

EXPLODED DRAWING B

Model No. PETL15816.1 R0917A

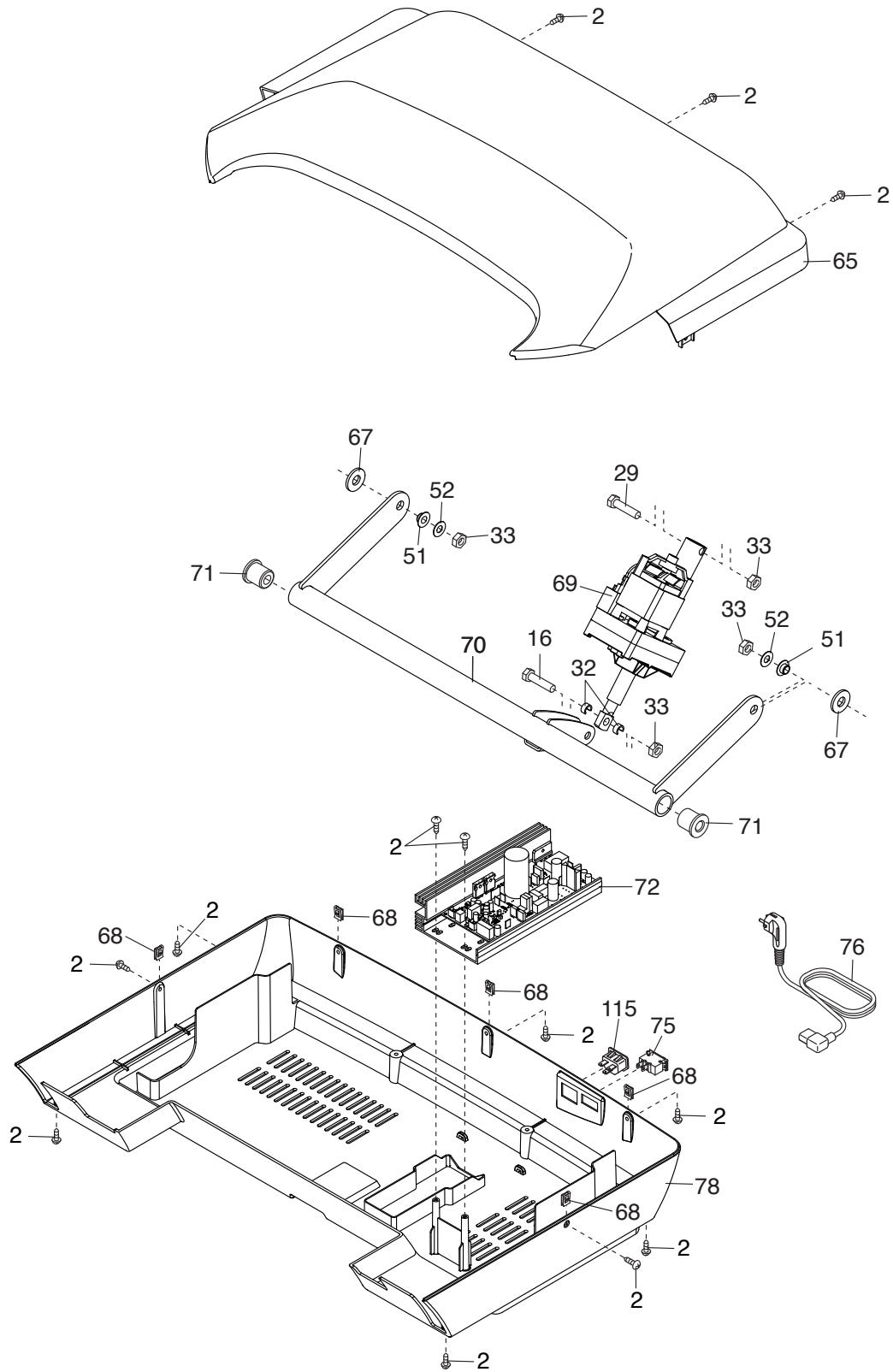

EXPLODED DRAWING C

Model No. PETL15816.1 R0917A

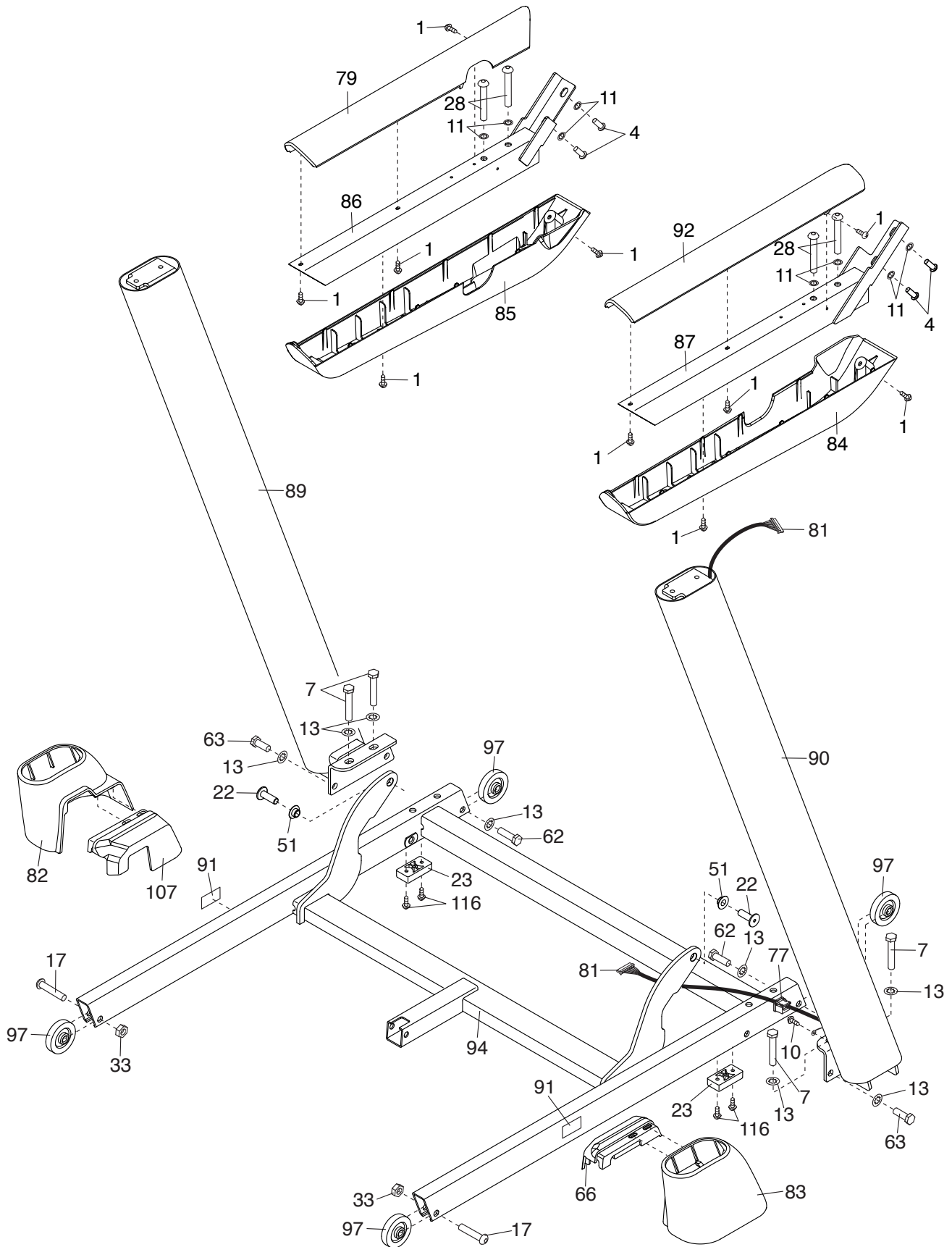

EXPLODED DRAWING D

Model No. PETL15816.1 R0917A

