

# EXPLODED DRAWING A

Model No. PETL15816.0 R0416A

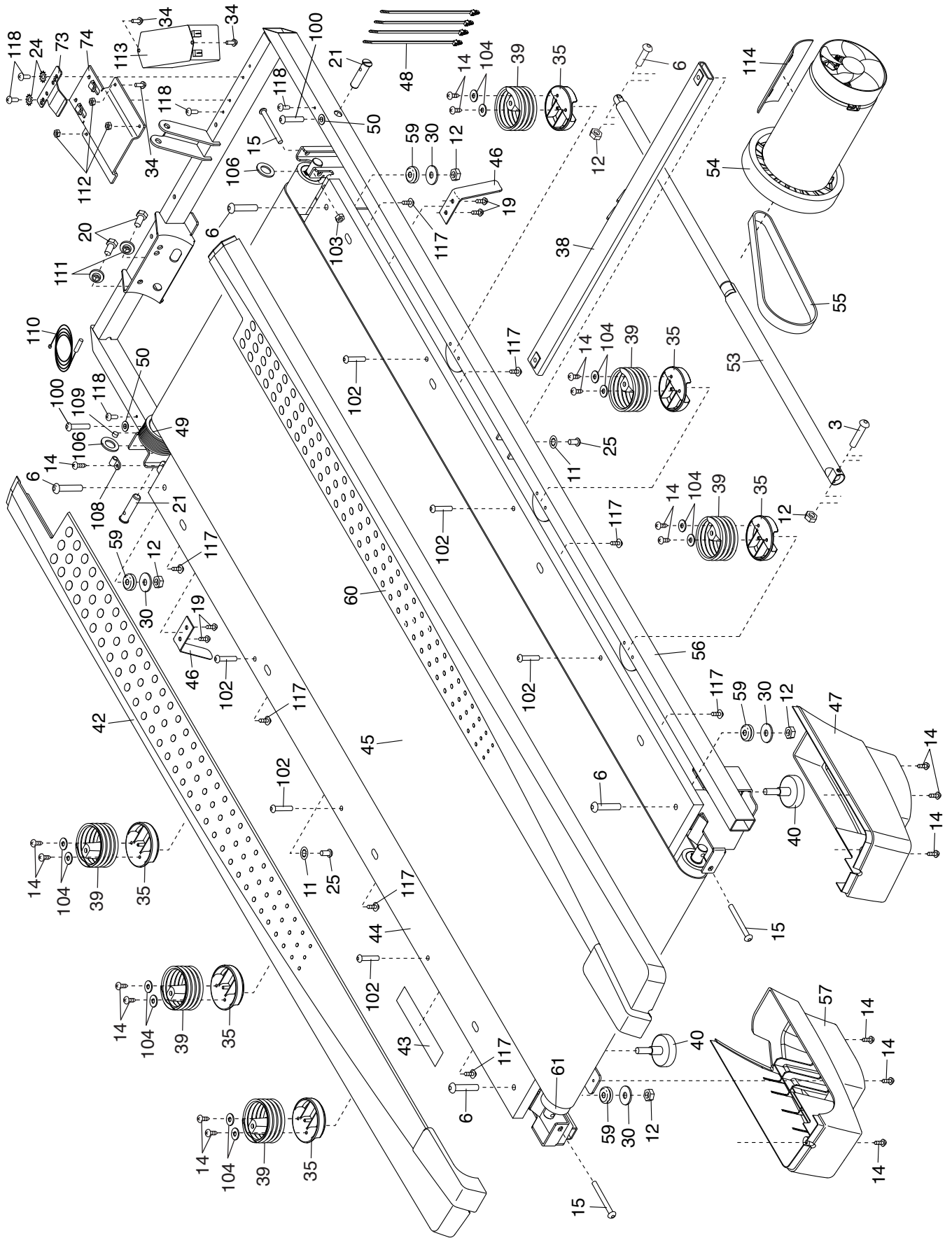

# EXPLODED DRAWING B

Model No. PETL15816.0 R0416A

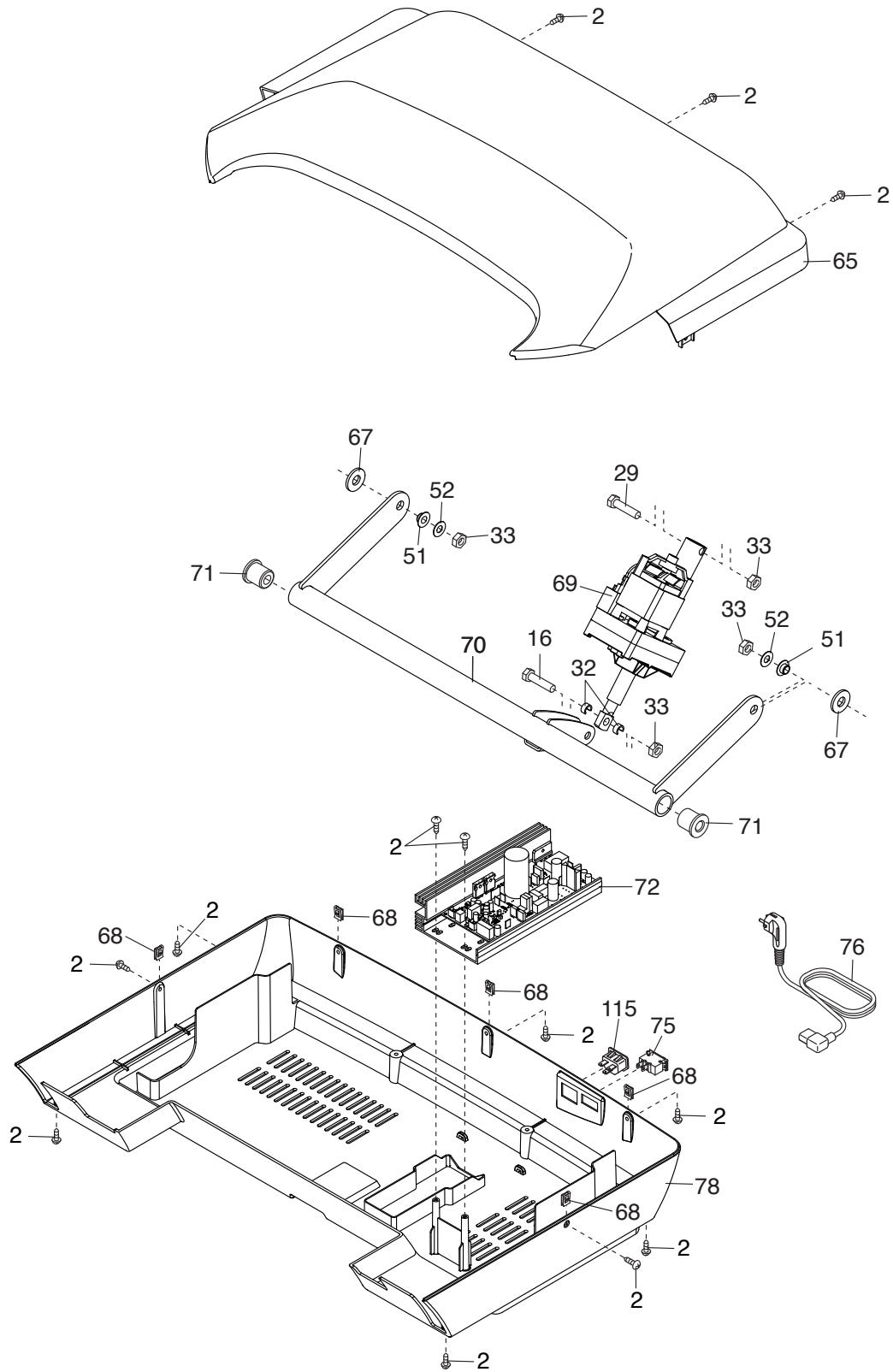

# EXPLODED DRAWING C

Model No. PETL15816.0 R0416A

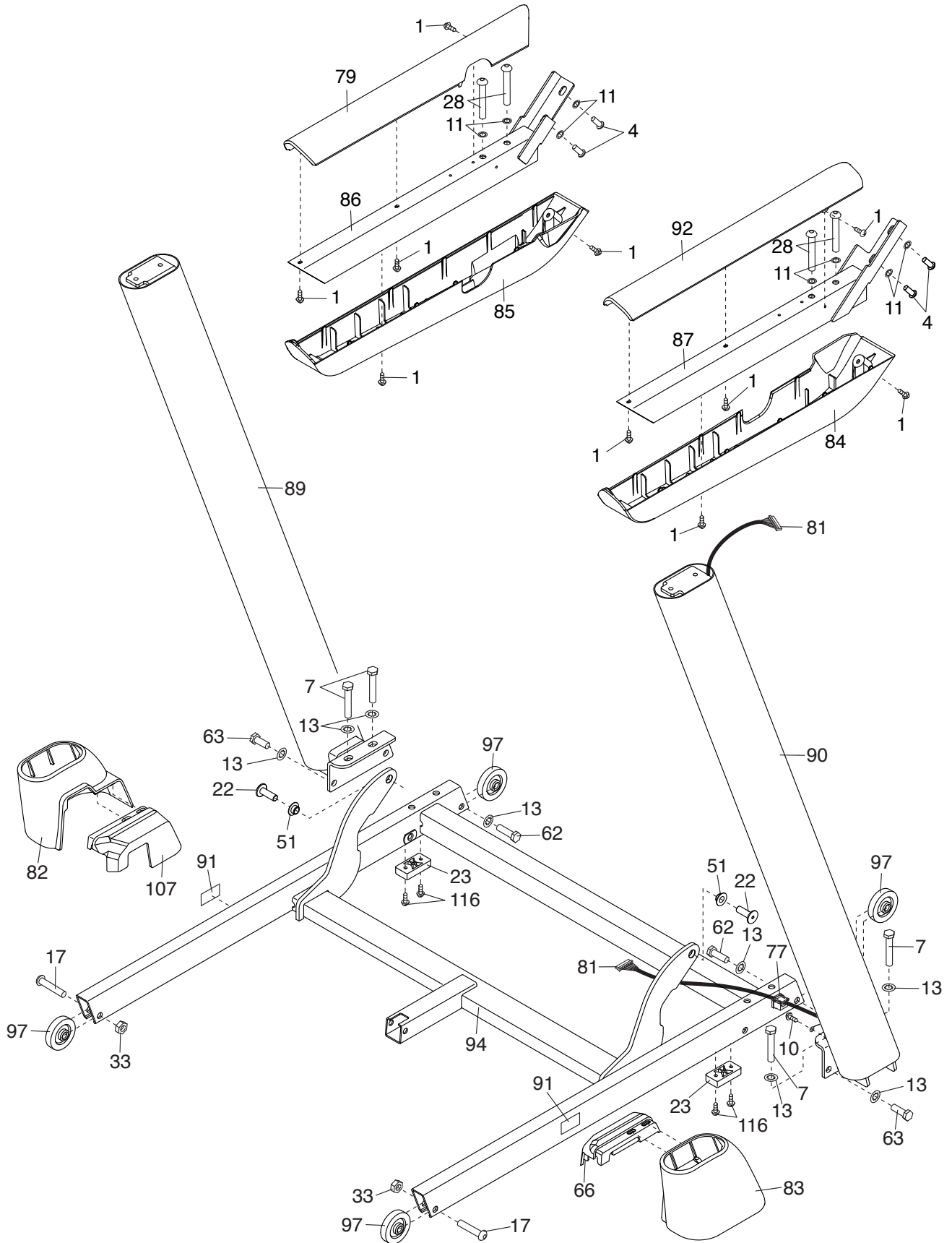

# EXPLODED DRAWING D

Model No. PETL15816.0 R0416A

