

# EXPLODED DRAWING A—Model No. PETL40707.2

R0709A

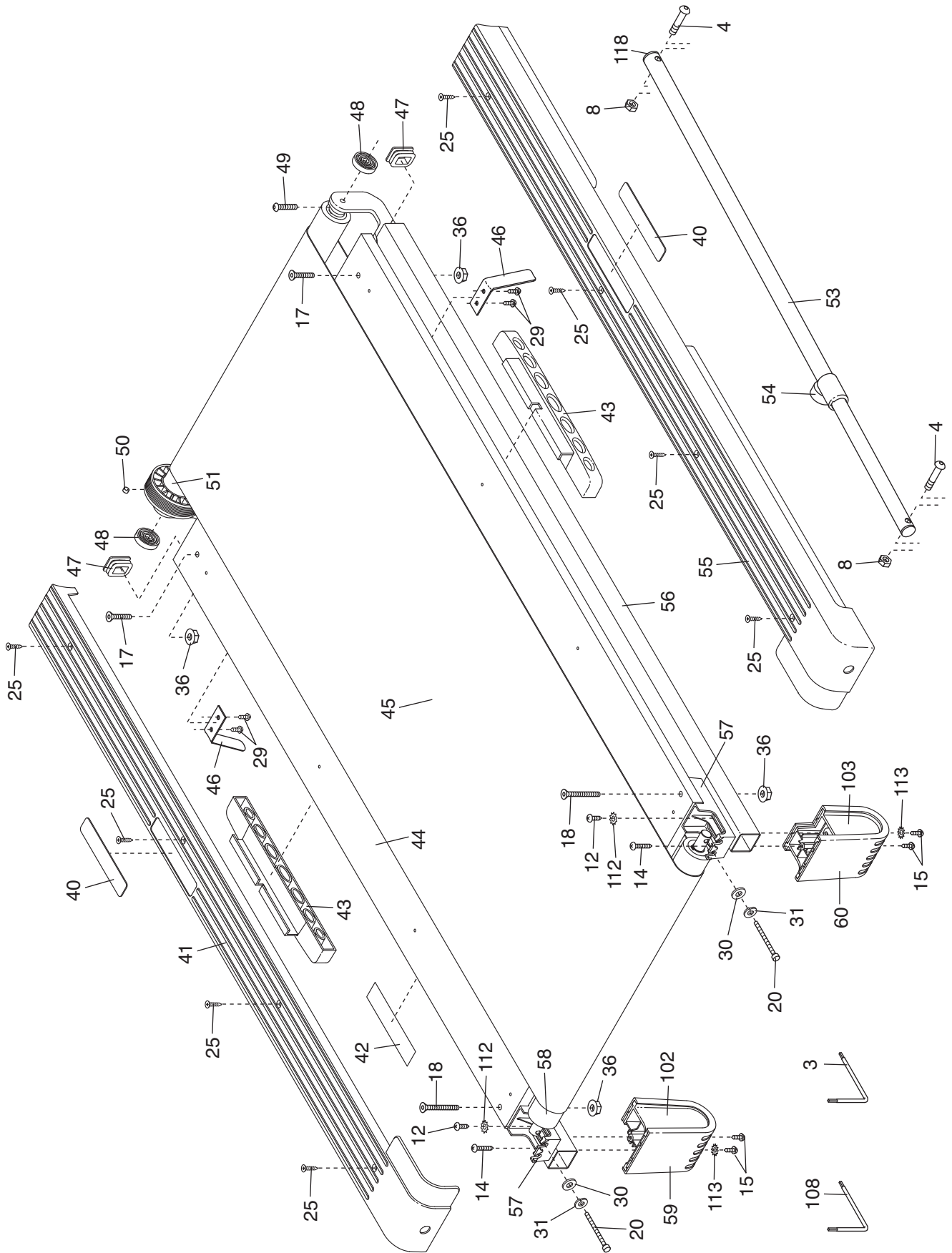

# EXPLODED DRAWING B—Model No. PETL40707.2

R0709A

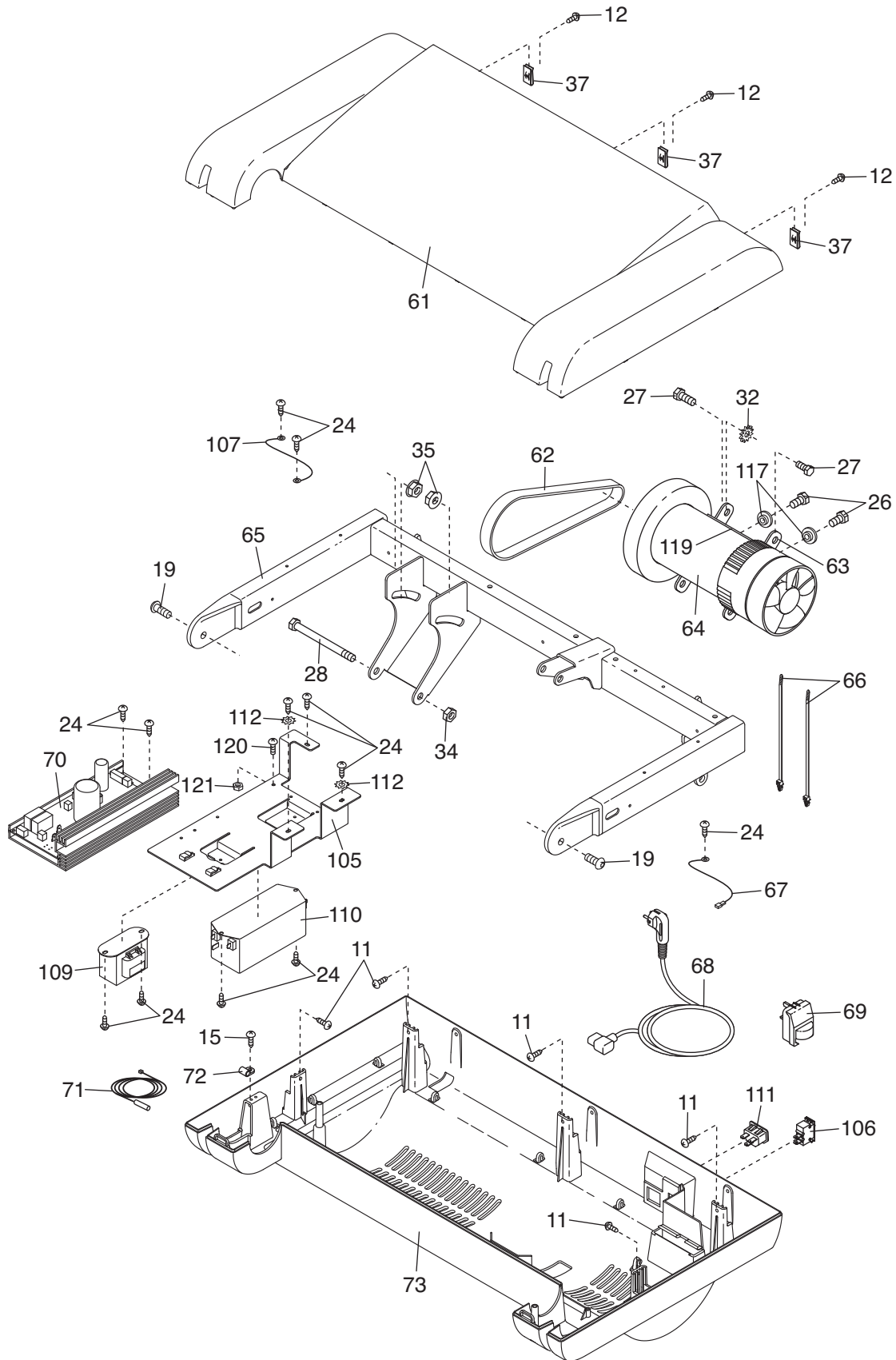



# EXPLODED DRAWING D—Model No. PETL40707.2

R0709A

