

# EXPLODED DRAWING A—Model No. PETL40807.0

R0907A

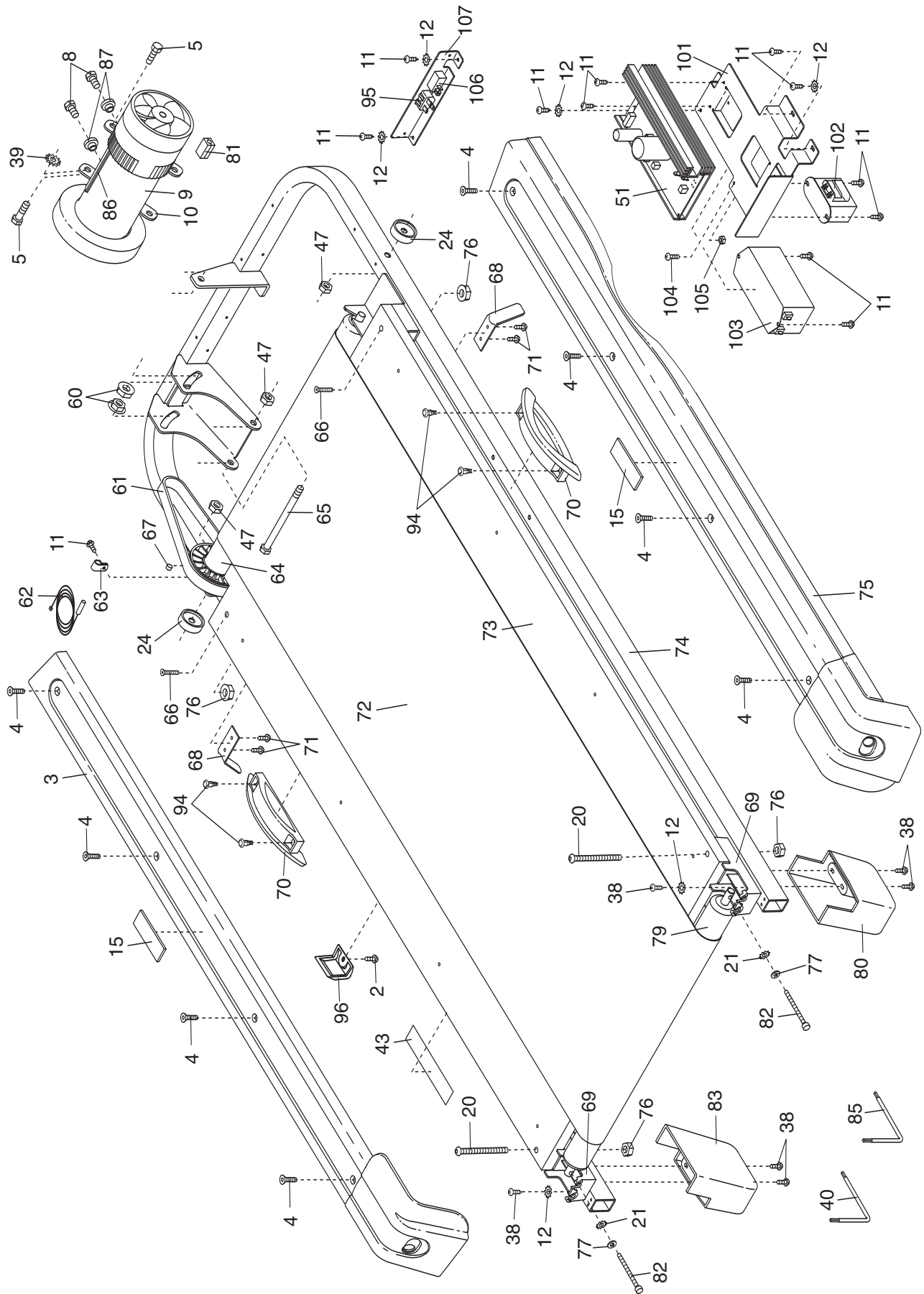

# EXPLODED DRAWING B—Model No. PETL40807.0

R0907A

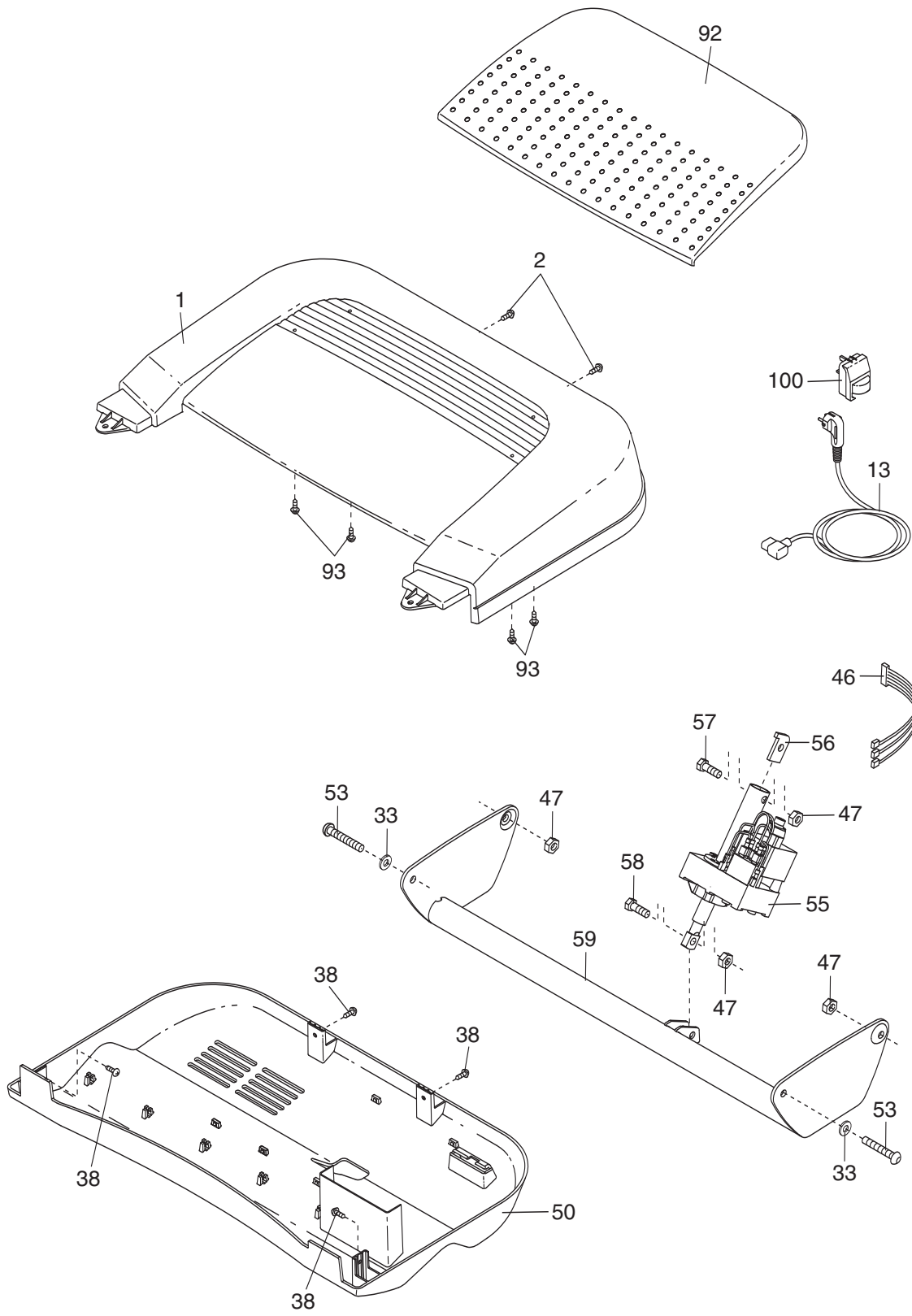

# EXPLODED DRAWING C—Model No. PETL40807.0

R0907A

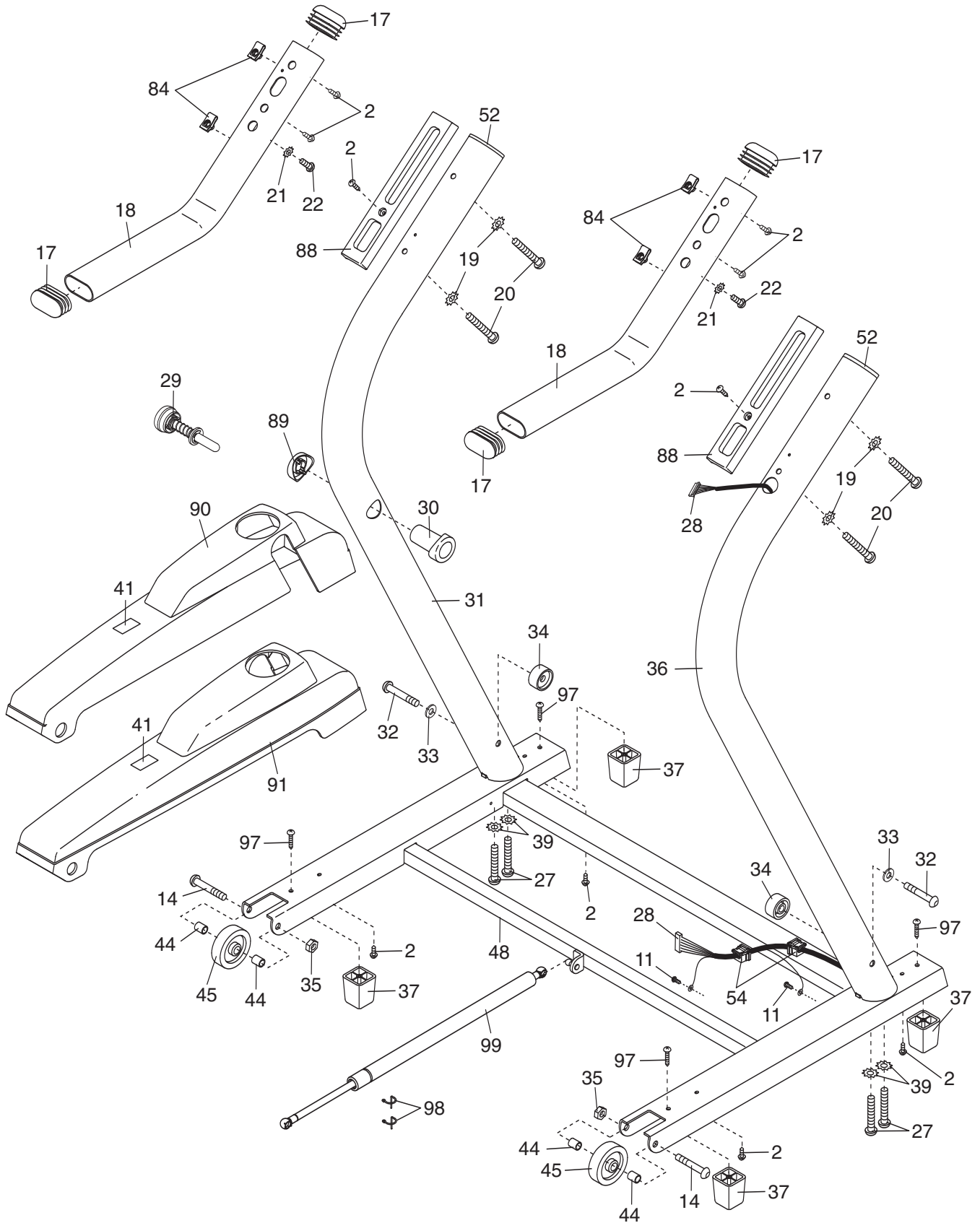

# EXPLODED DRAWING D—Model No. PETL40807.0

R0907A

