

EXPLODED DRAWING A—Model No. PETL41106.0

R0806A

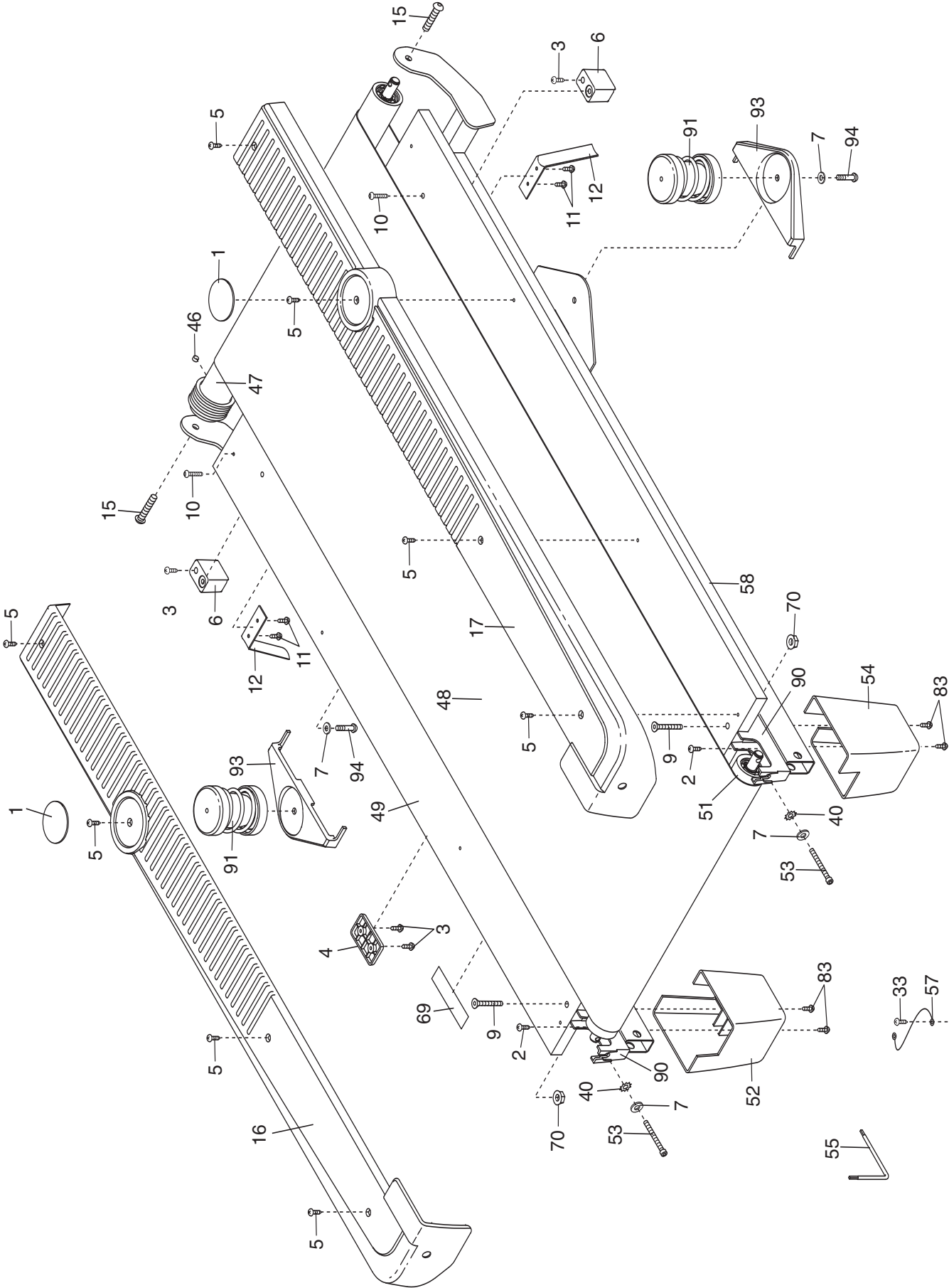

EXPLODED DRAWING B—Model No. PETL41106.0

R0806A

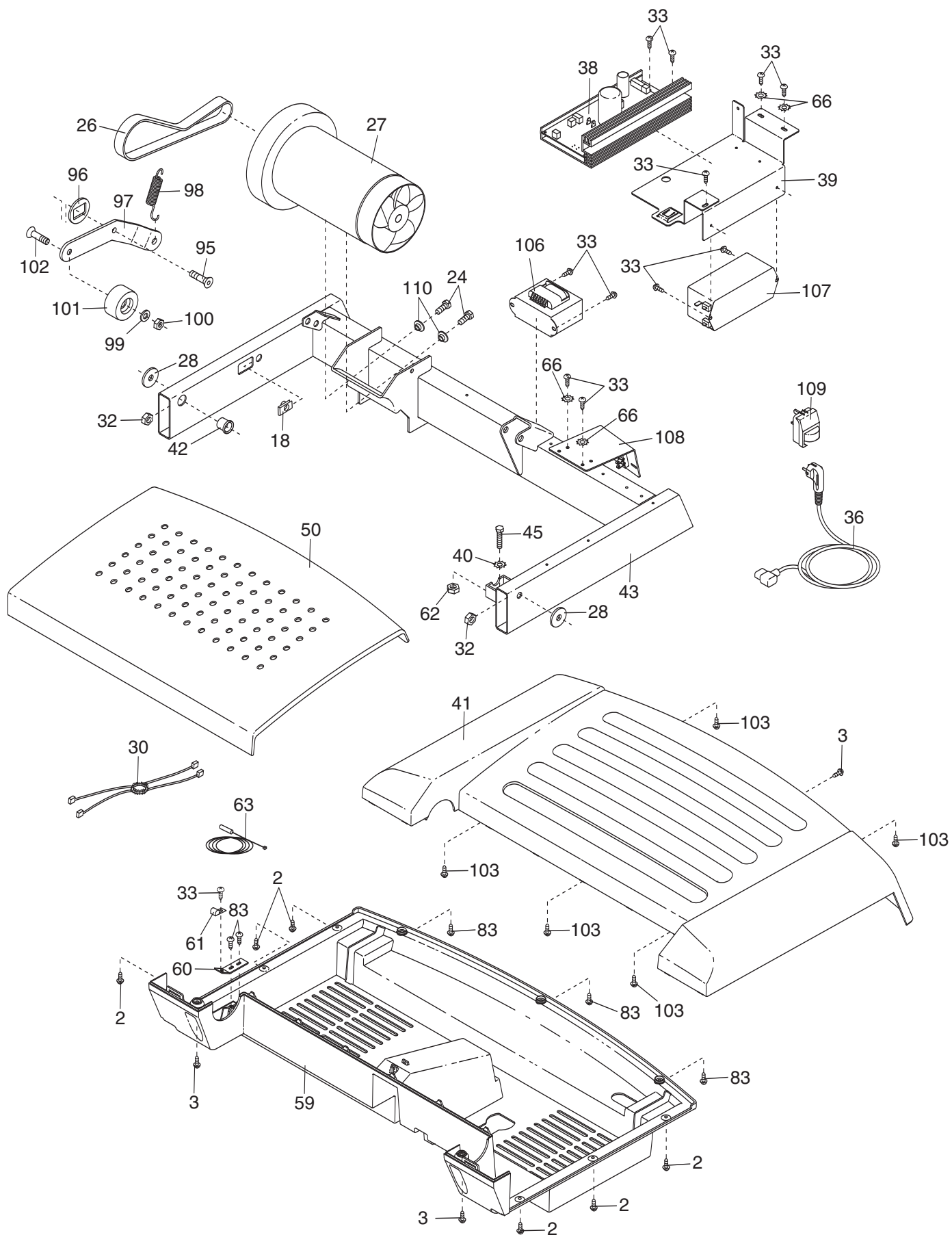

EXPLODED DRAWING C—Model No. PETL41106.0

R0806A

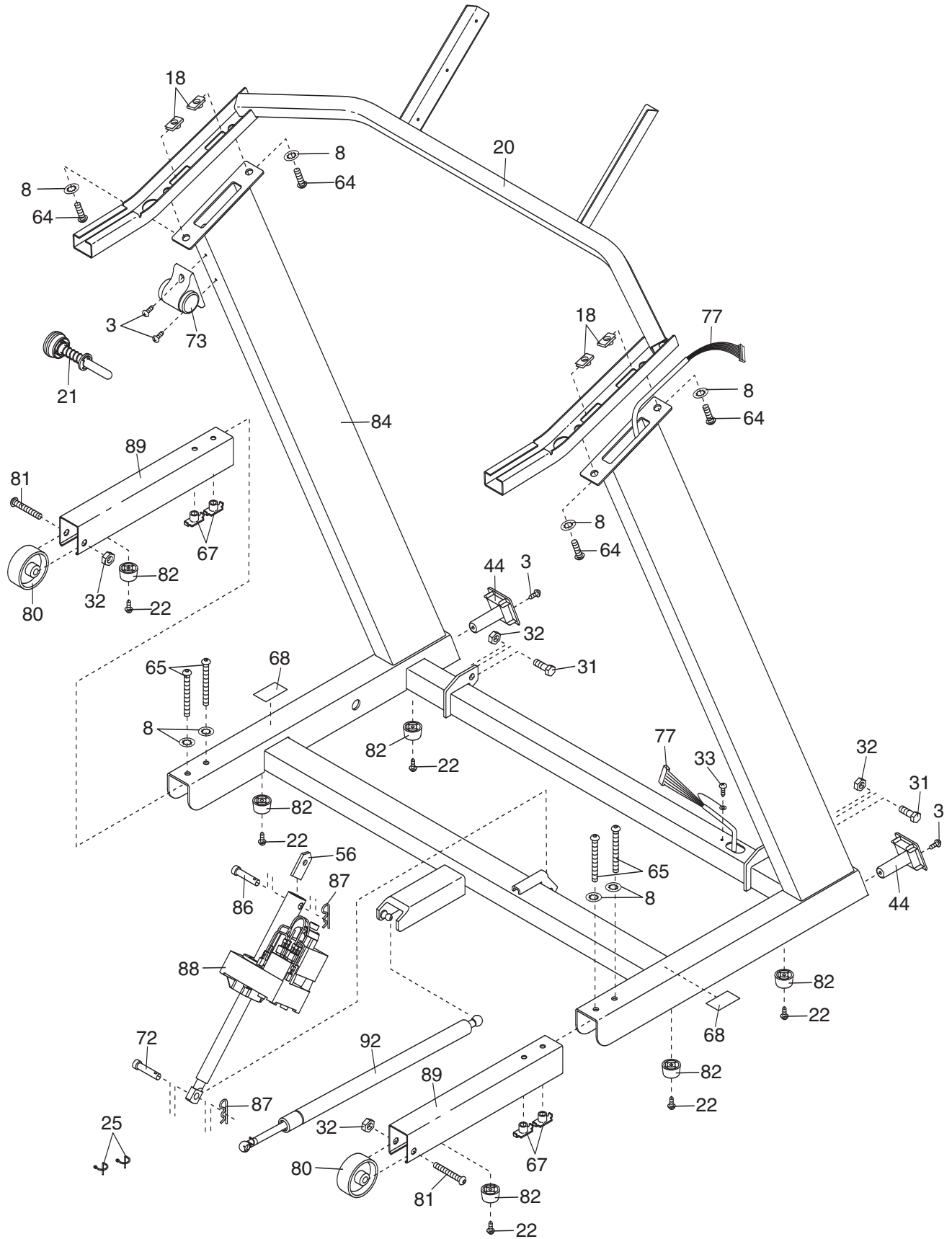

EXPLODED DRAWING D—Model No. PETL41106.0

R0806A

