

EXPLODED DRAWING A—Model No. PETL41307.0

R1207A

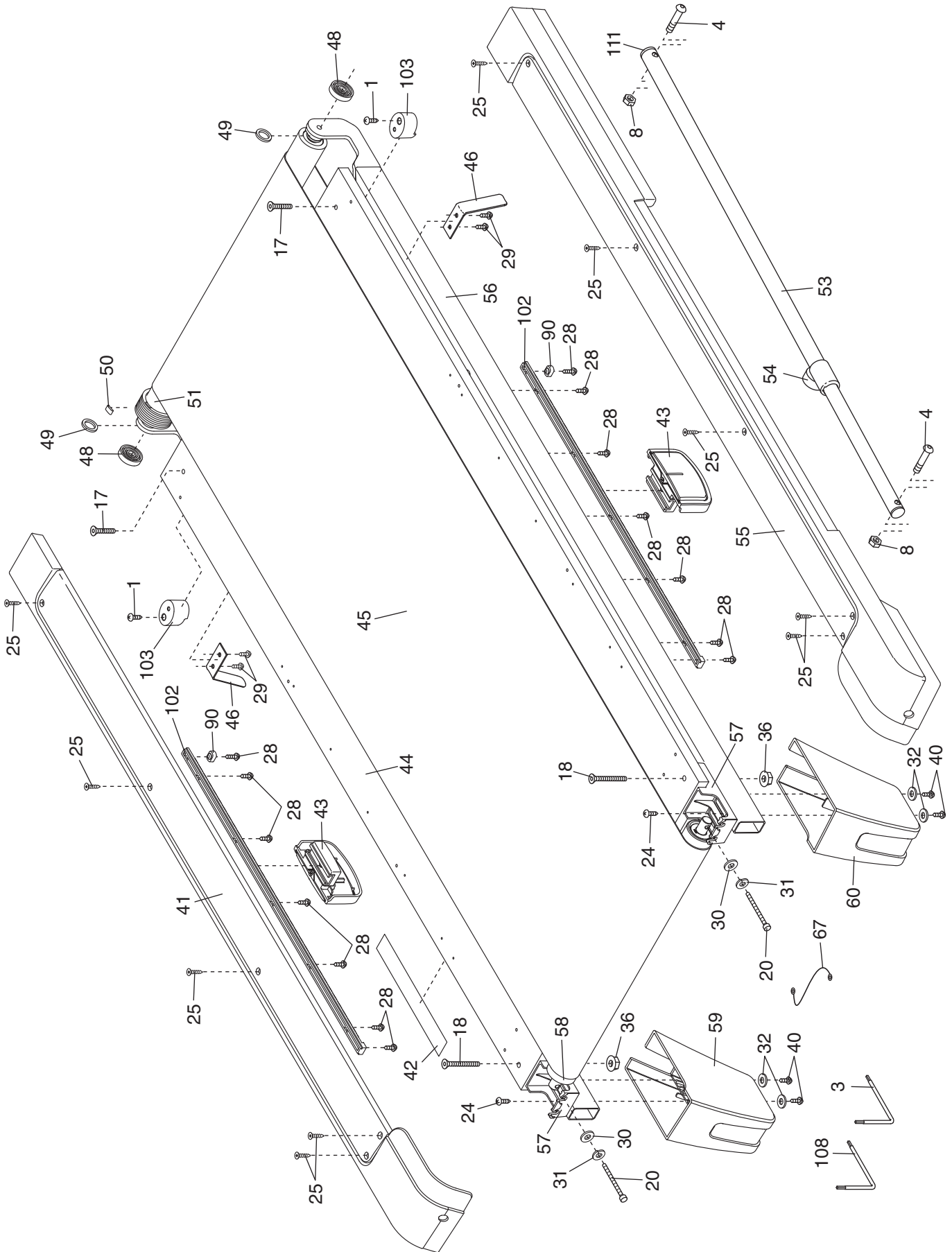

EXPLODED DRAWING B—Model No. PETL41307.0

R1207A

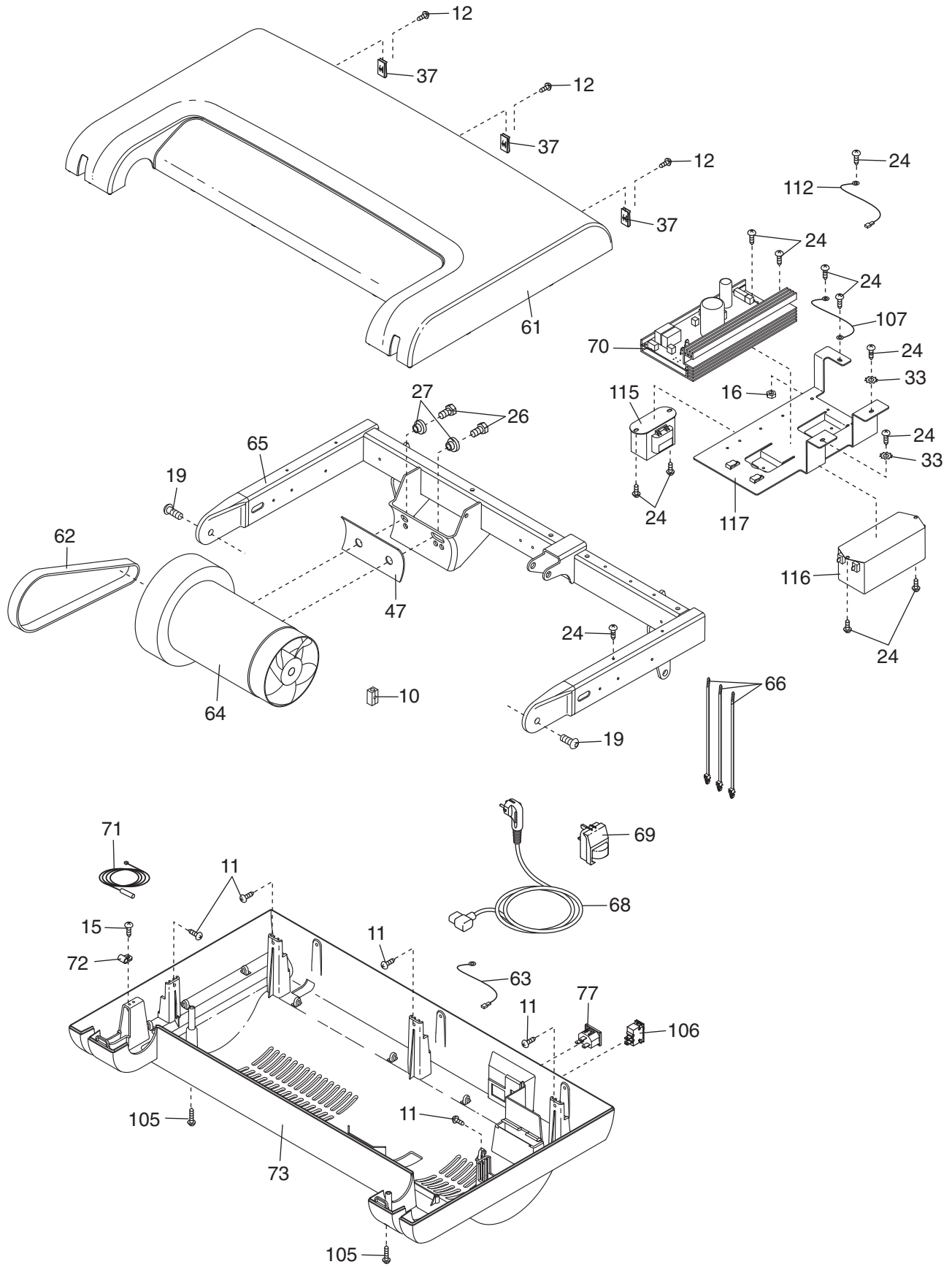

EXPLODED DRAWING C—Model No. PETL41307.0

R1207A

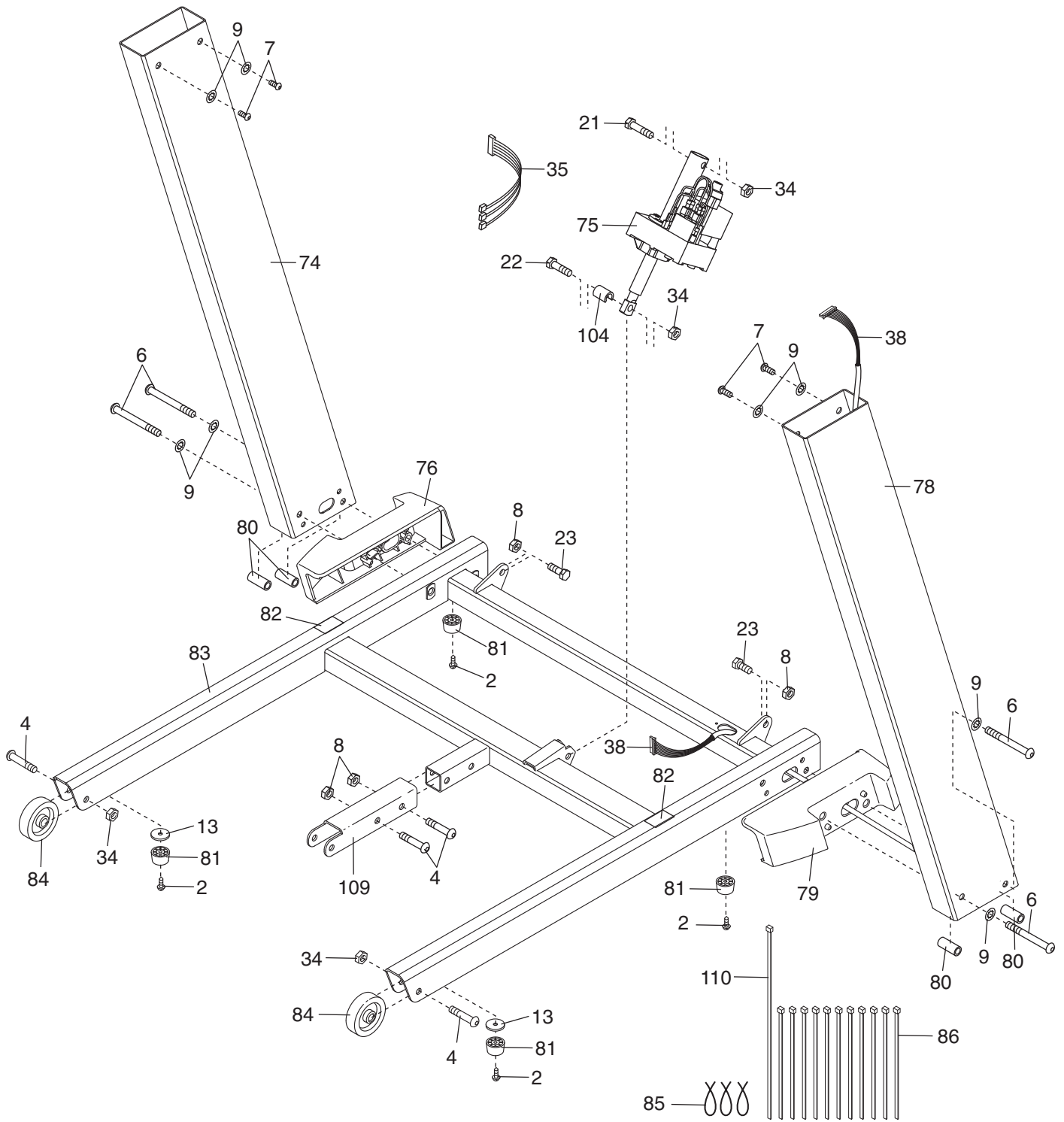

EXPLODED DRAWING D—Model No. PETL41307.0

R1207A

