

# EXPLODED DRAWING A—Model No. PETL50707.0

R0807A

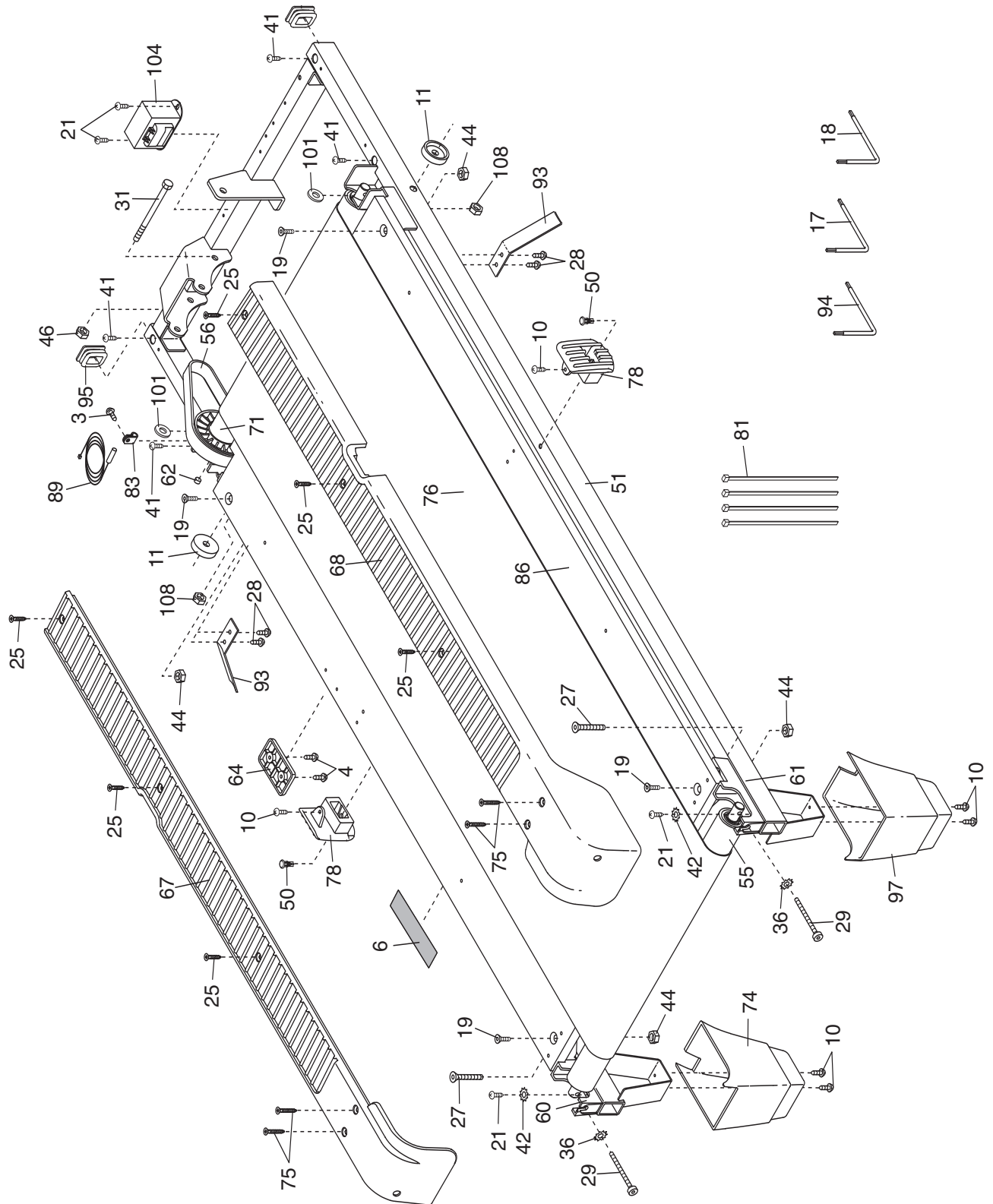

# EXPLODED DRAWING B—Model No. PETL50707.0

R0807A

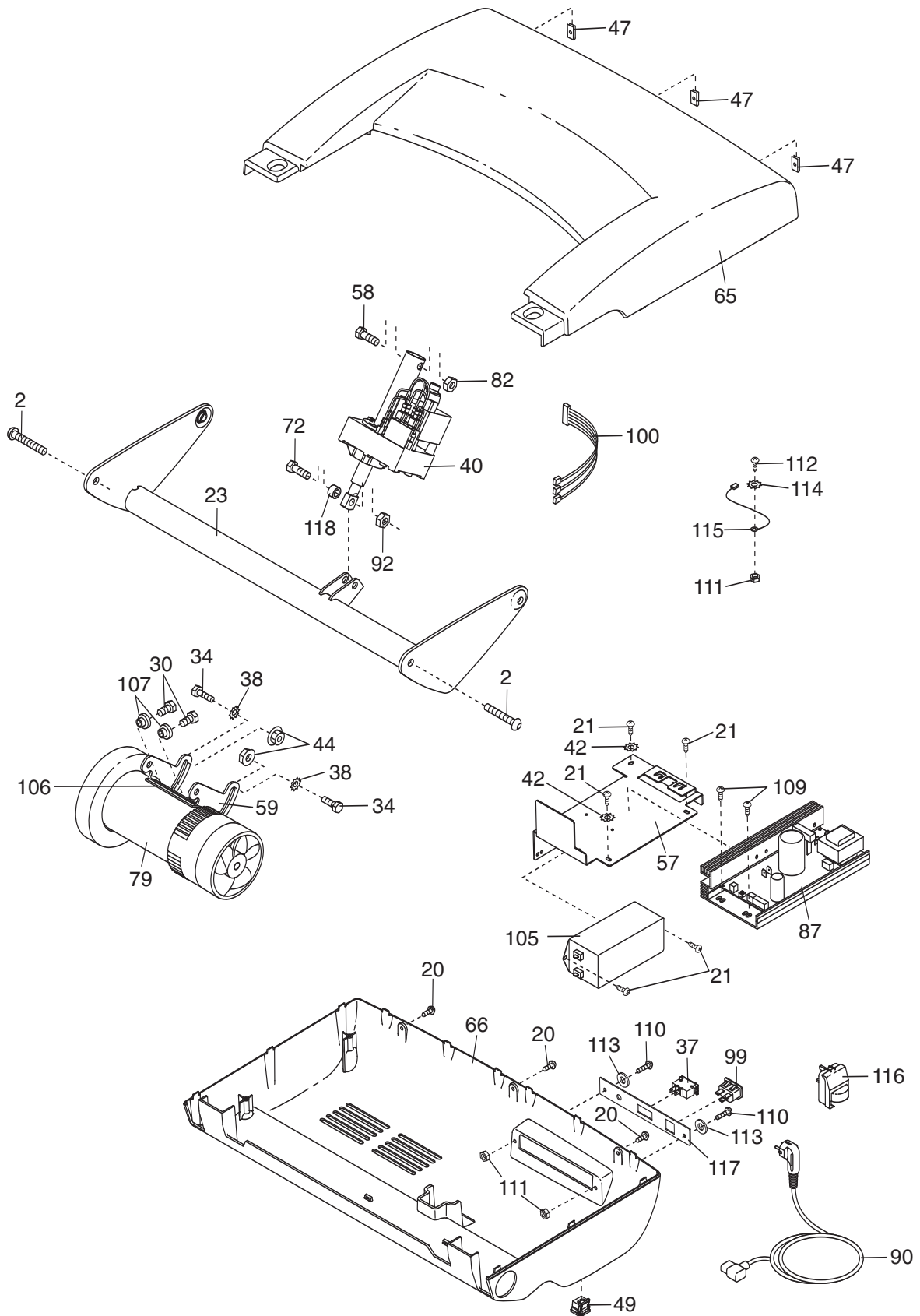

# EXPLODED DRAWING C—Model No. PETL50707.0

R0807A

