

EXPLODED DRAWING—Model No. PETL5513.3

R0205A

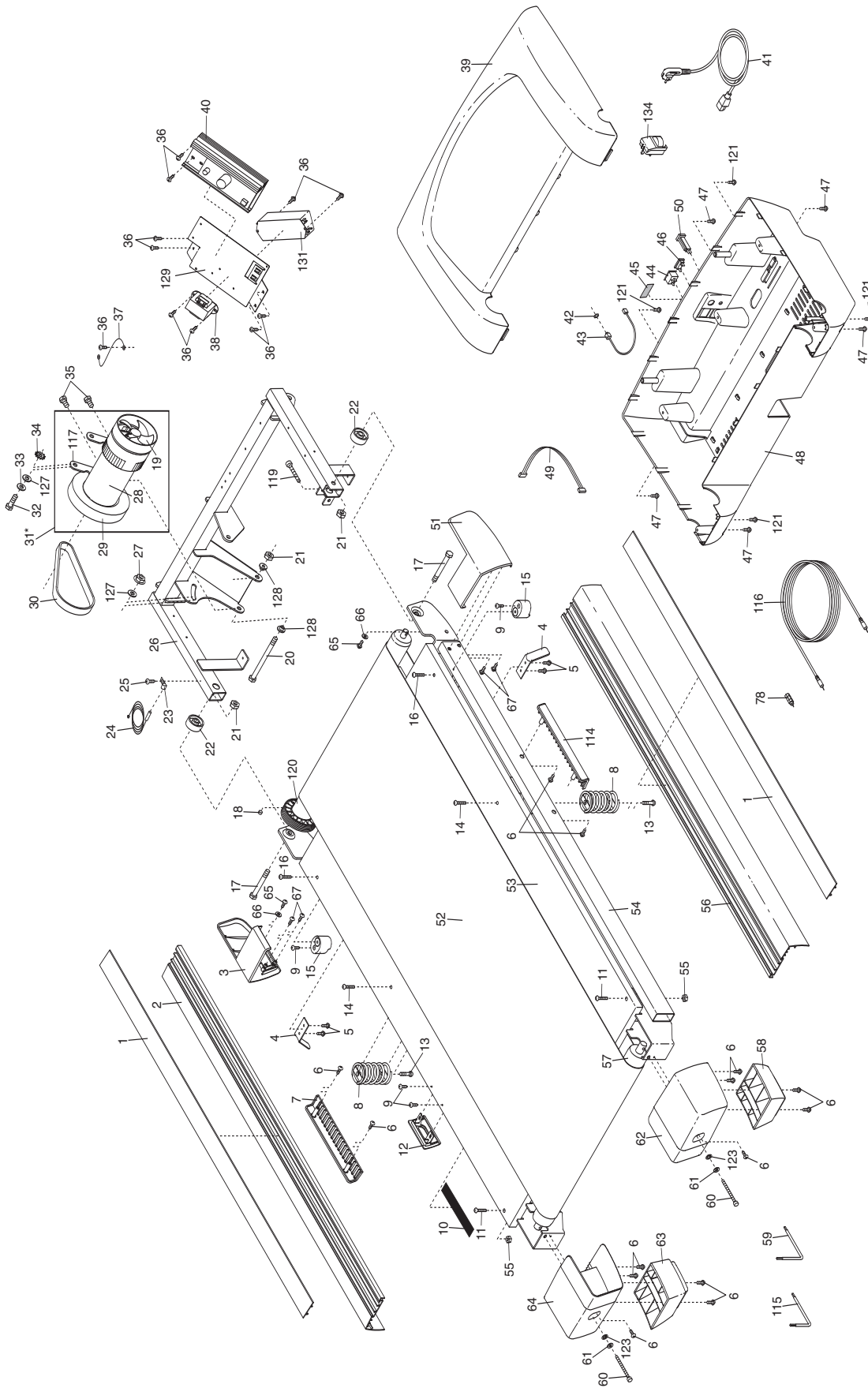

To identify the parts shown on this EXPLODED DRAWING, see the PART LIST on pages 30 and 31 of the user's manual.

EXPLODED DRAWING—Model No. PETL5513.3

R0205A

