

EXPLODED DRAWING A

Model No. PETL59713.1 R0215A

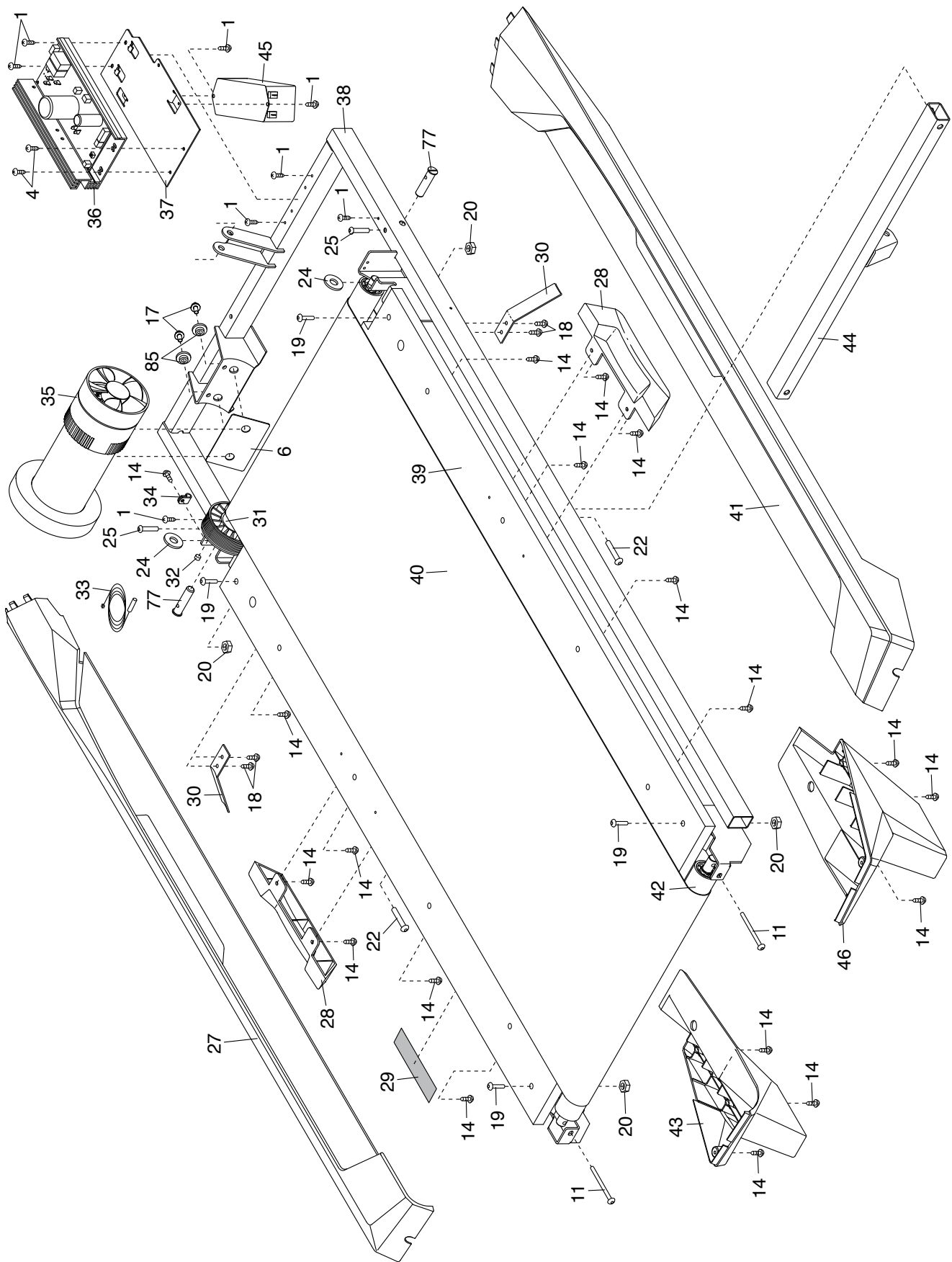

EXPLODED DRAWING B

Model No. PETL59713.1 R0215A

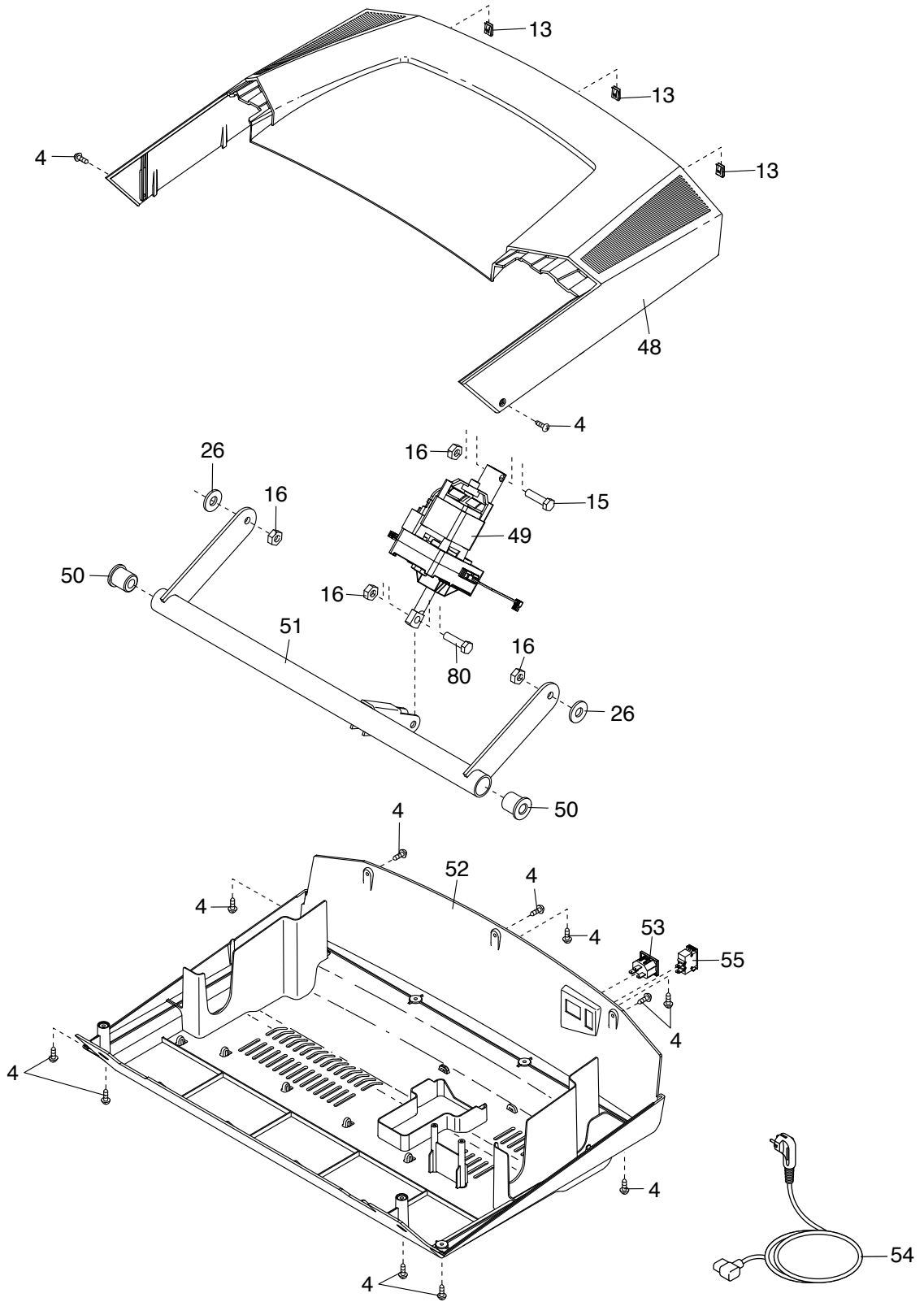

EXPLODED DRAWING C

Model No. PETL59713.1 R0215A

