

EXPLODED DRAWING A

Model No. PETL59714.0 R0114A

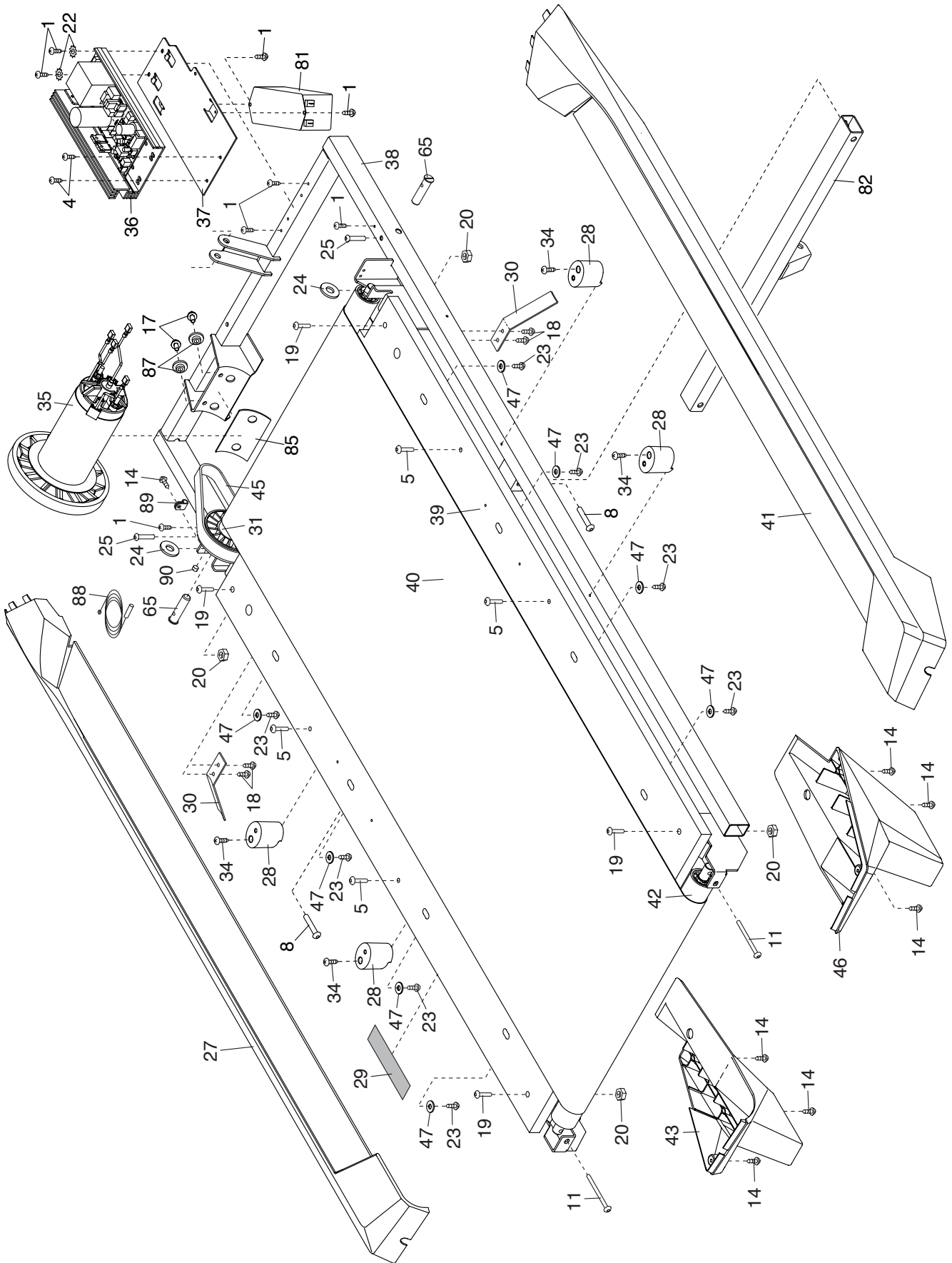

EXPLODED DRAWING B

Model No. PETL59714.0 R0114A

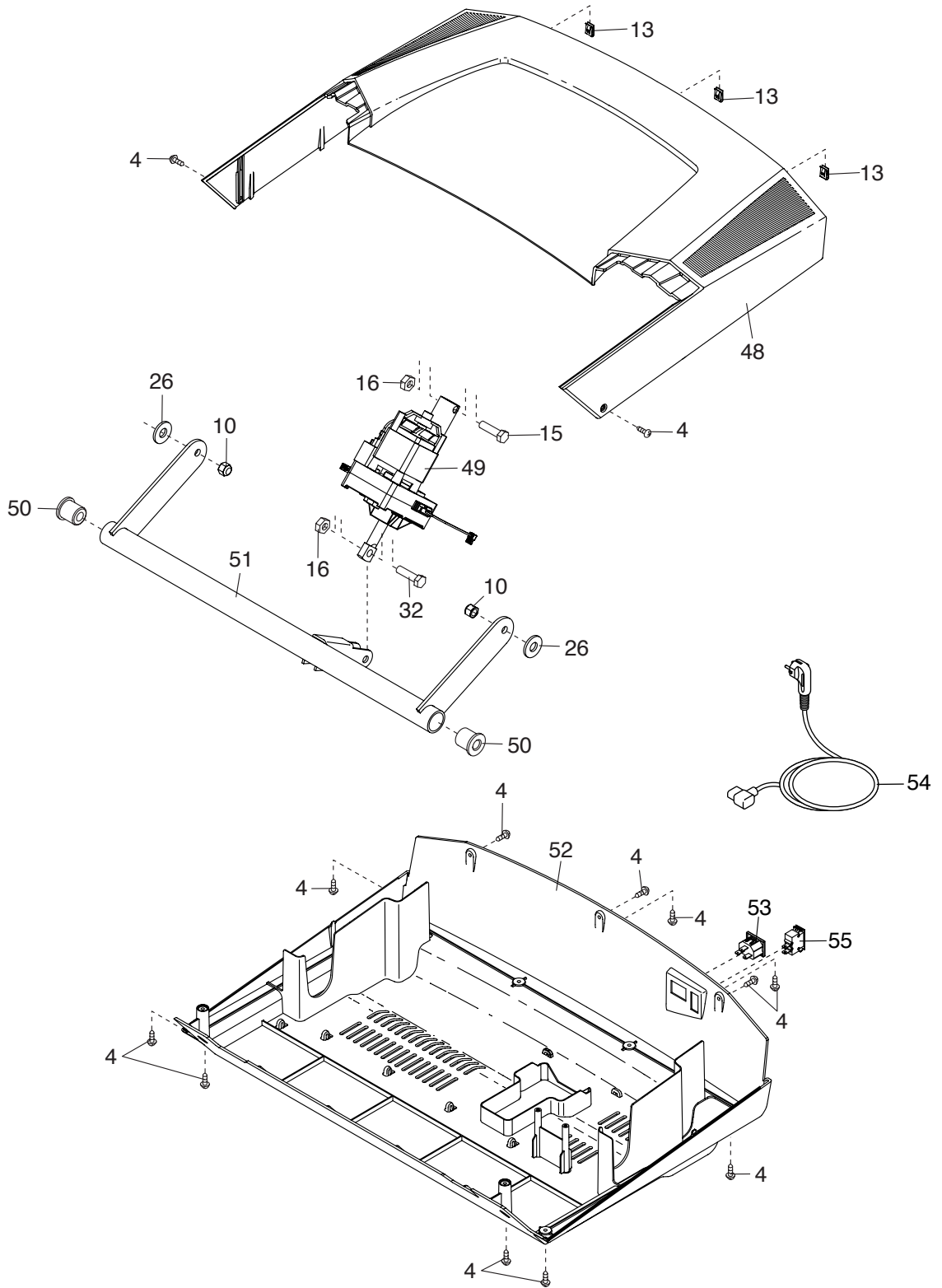

EXPLODED DRAWING C

Model No. PETL59714.0 R0114A

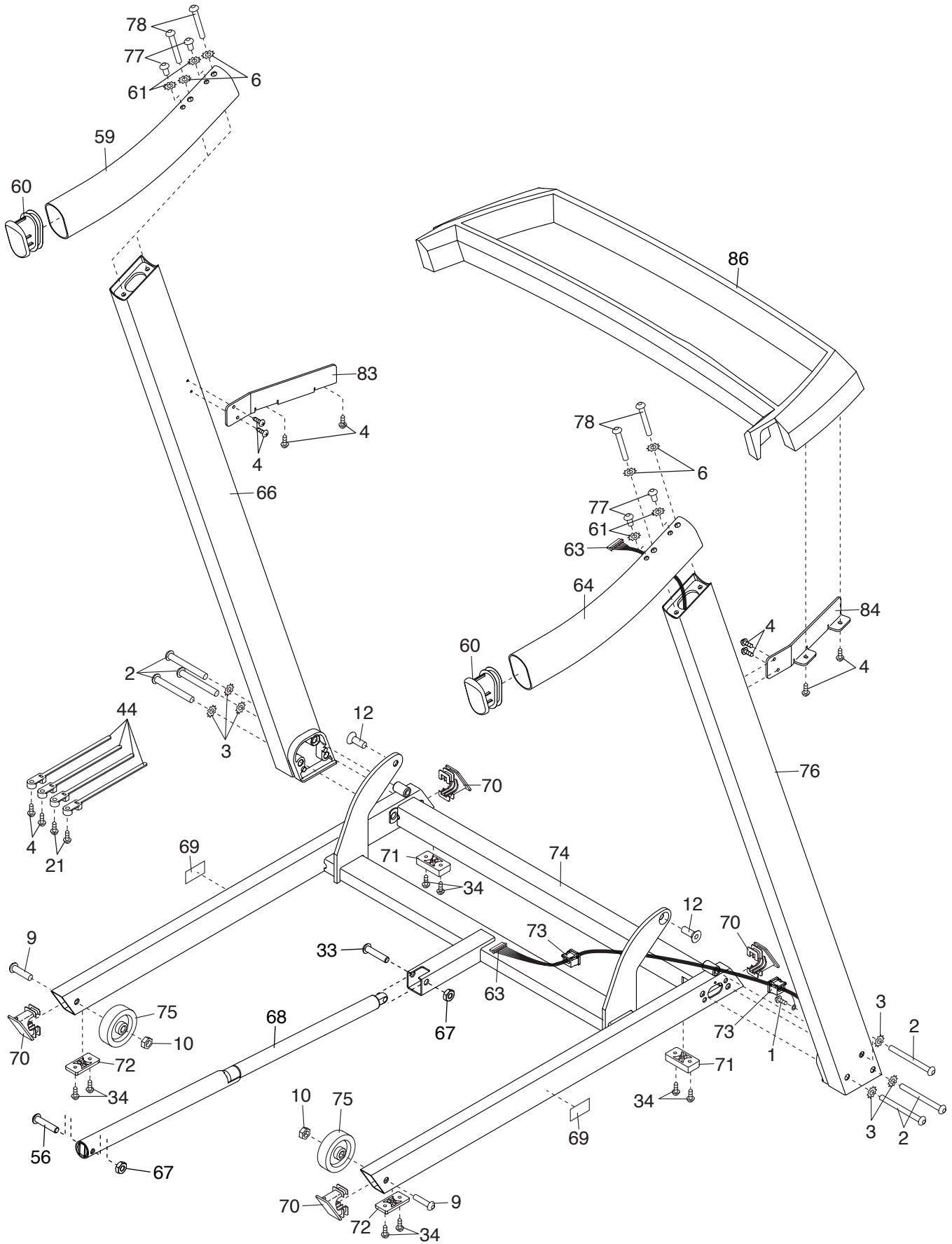

EXPLODED DRAWING D

Model No. PETL59714.0 R0114A

