

# EXPLODED DRAWING A

Model No. PETL59814.2 R1014A

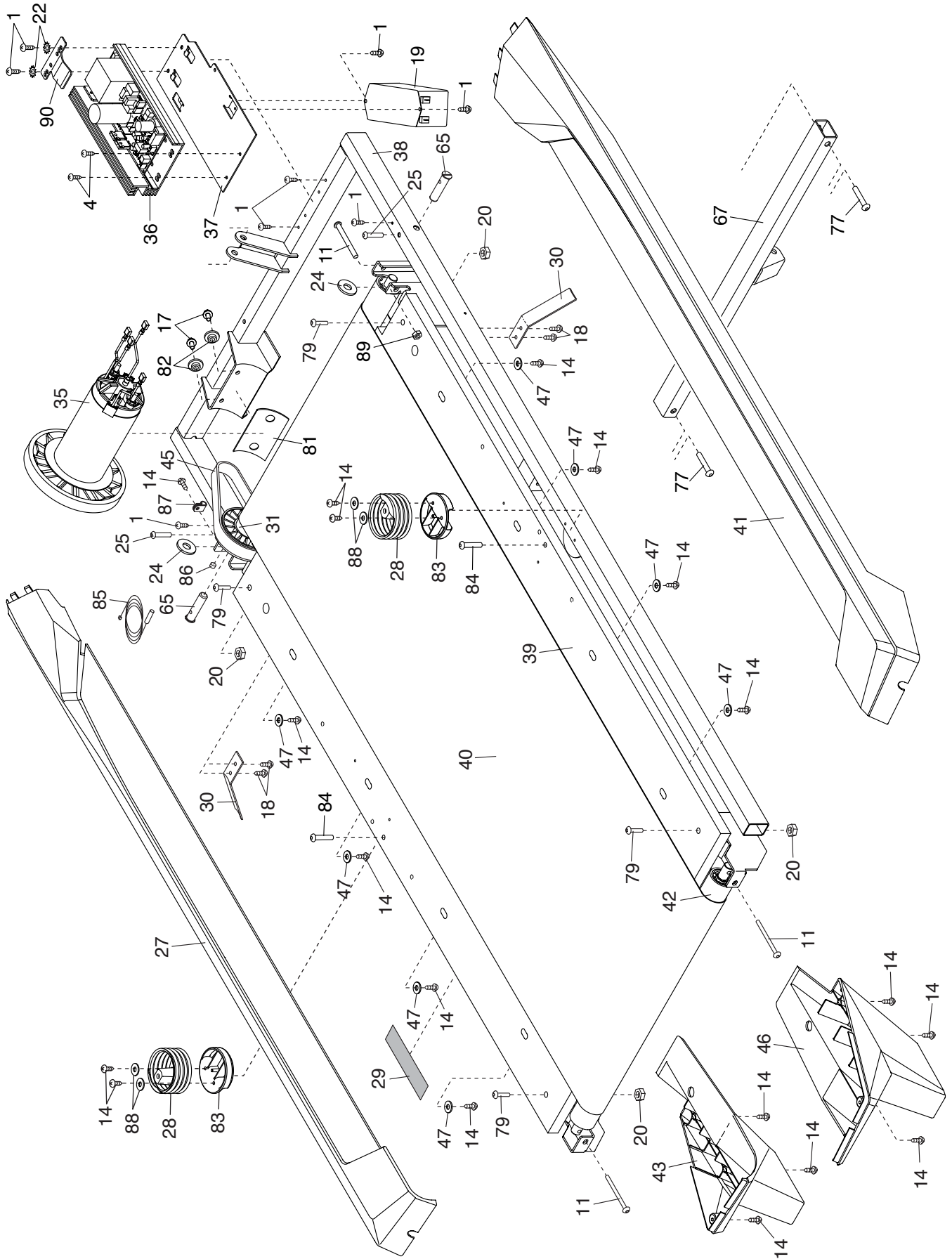

# EXPLODED DRAWING B

Model No. PETL59814.2 R1014A

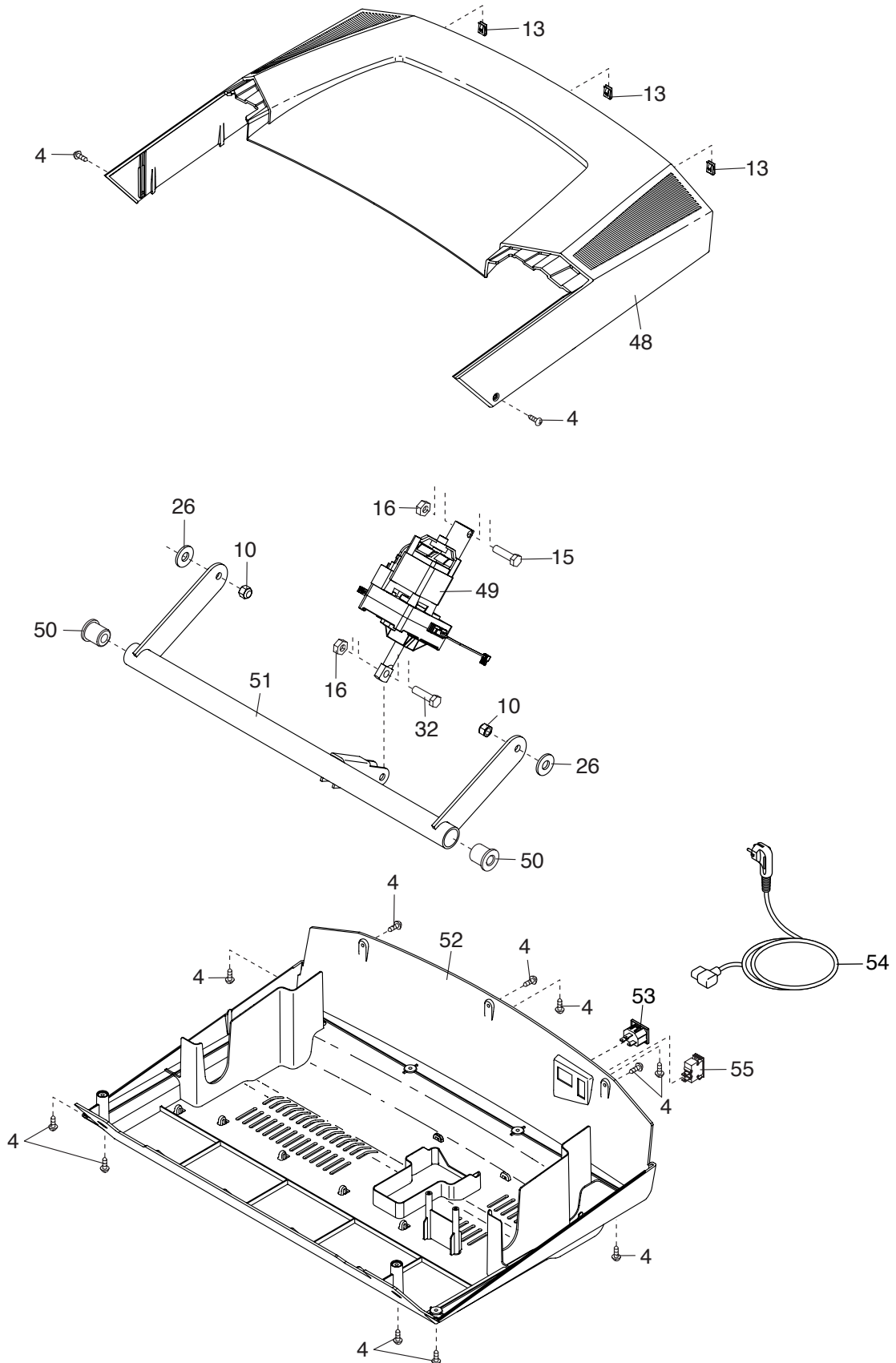

# EXPLODED DRAWING C

Model No. PETL59814.2 R1014A

