

EXPLODED DRAWING A

Model No. PETL59815.1 R0115A

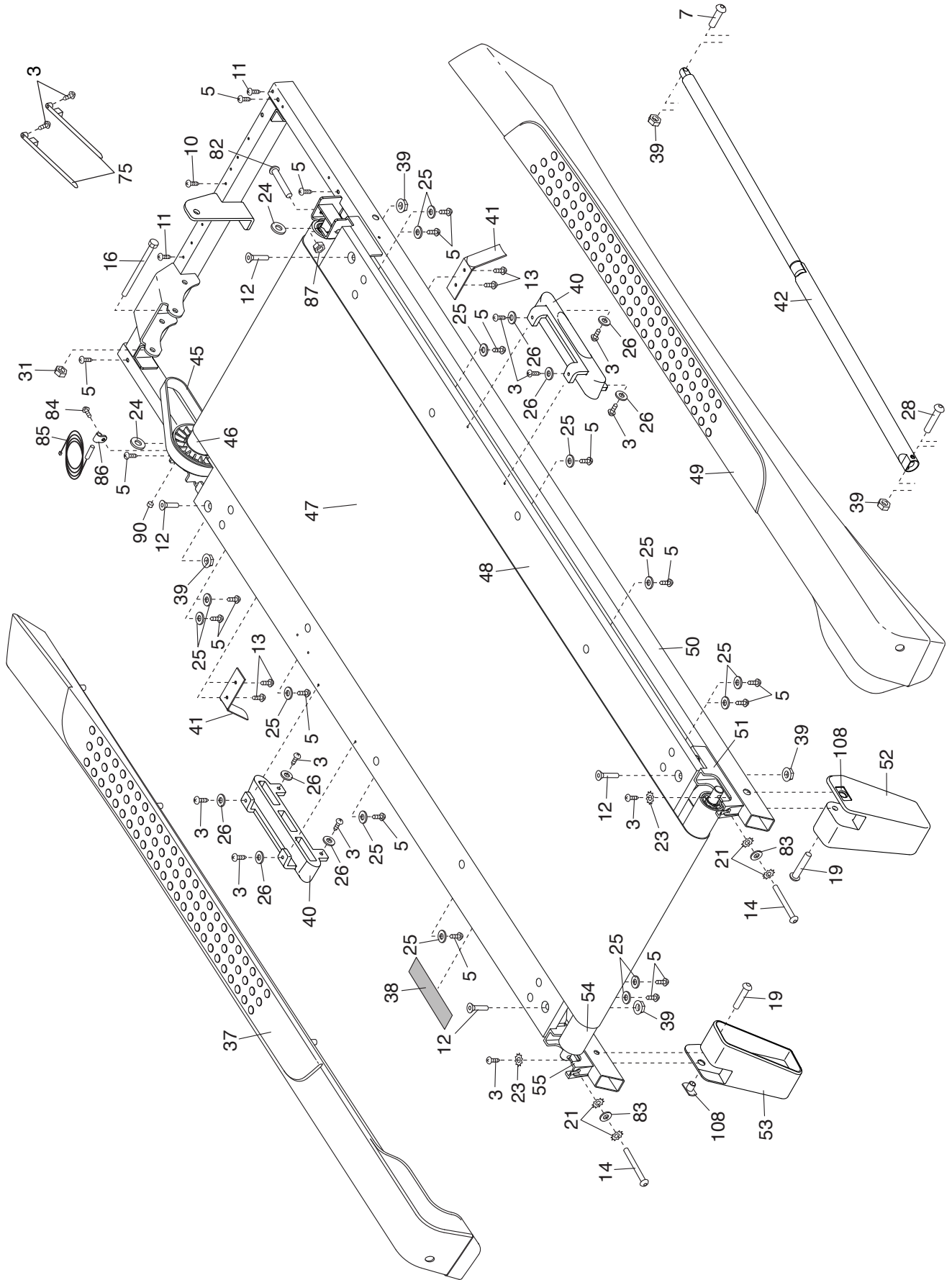

EXPLODED DRAWING B

Model No. PETL59815.1 R0115A

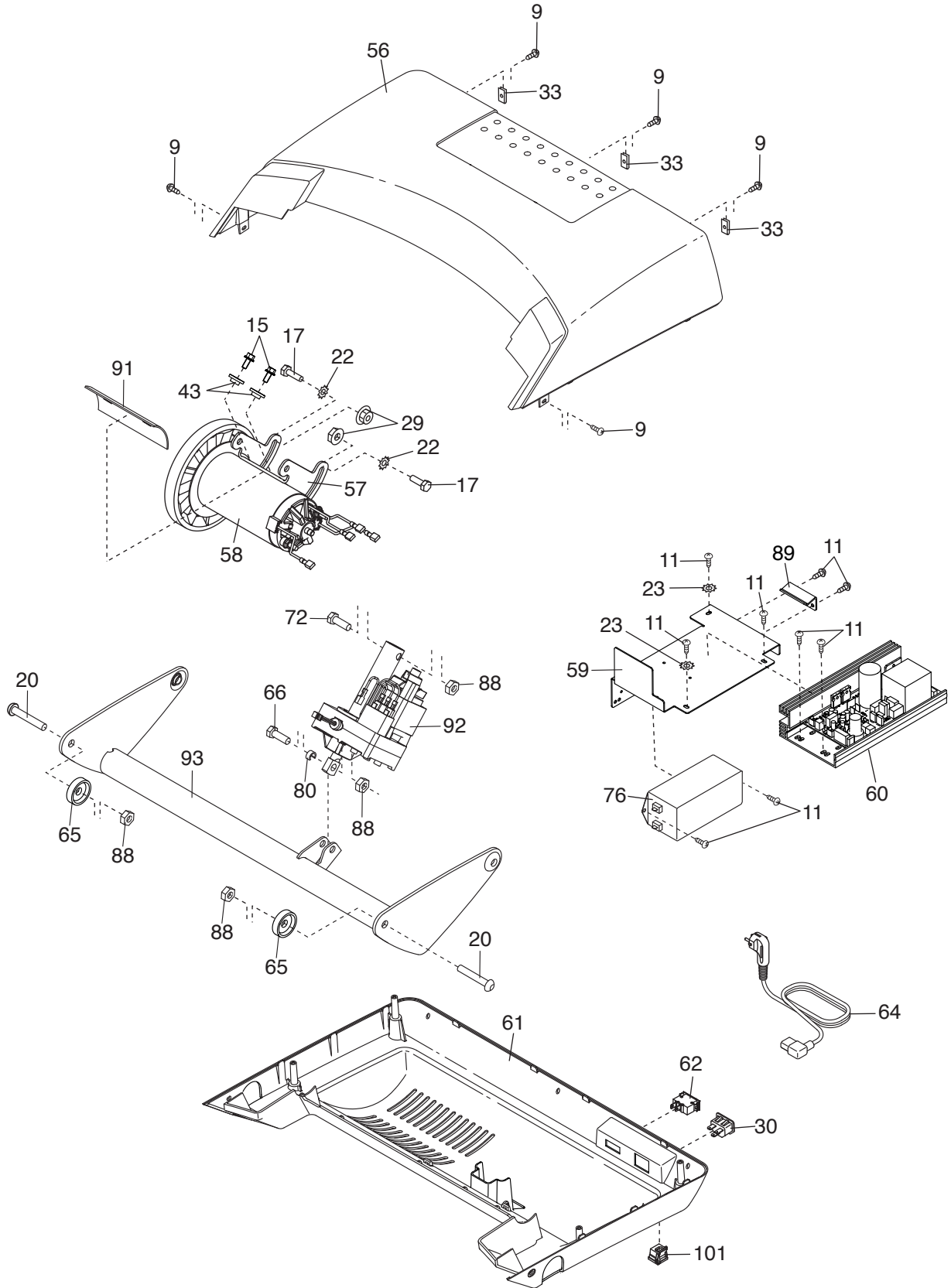

EXPLODED DRAWING C

Model No. PETL59815.1 R0115A

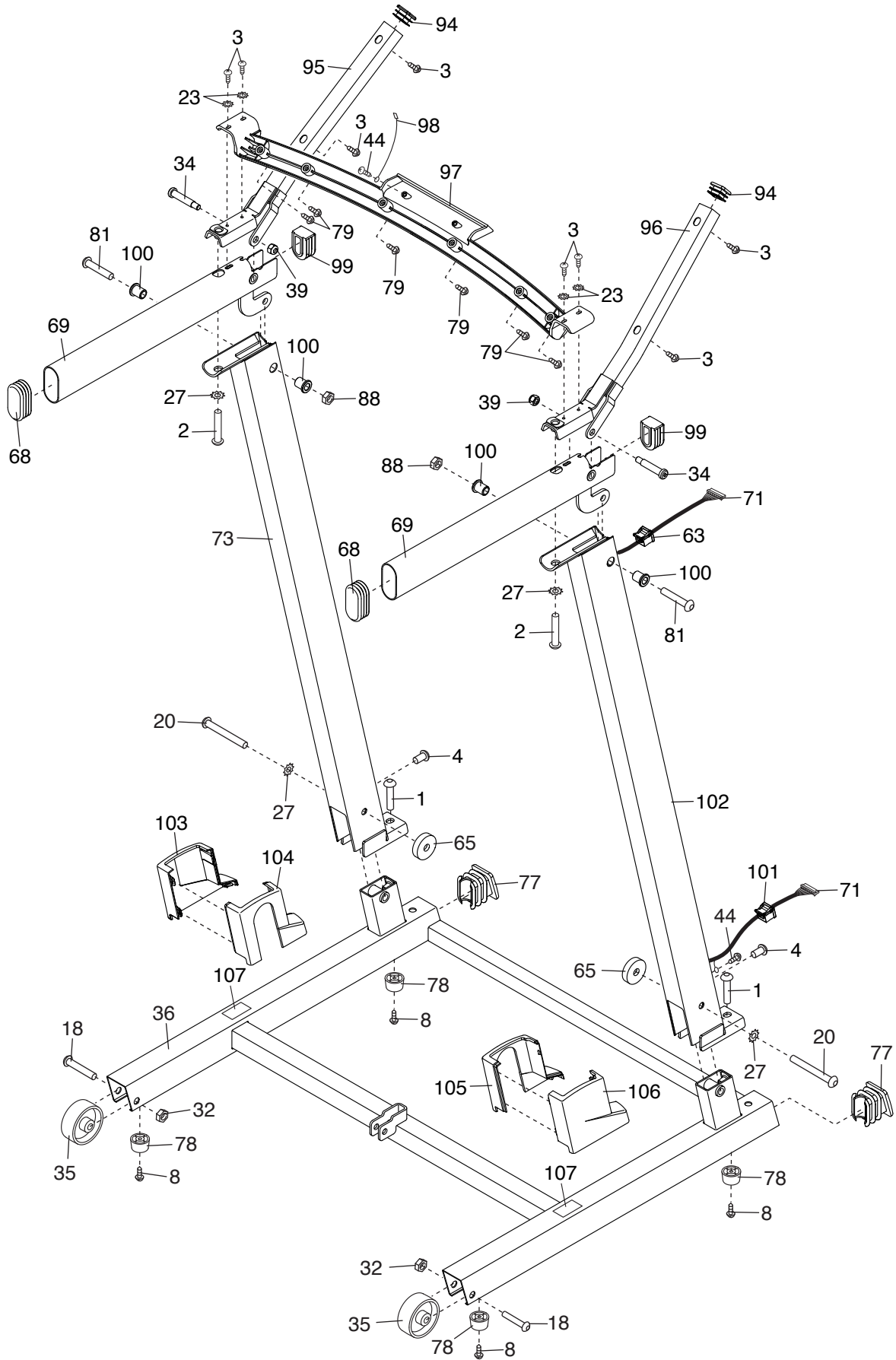

EXPLODED DRAWING D

Model No. PETL59815.1 R0115A

