

EXPLODED DRAWING A

Model No. PETL59819.0 R0919A

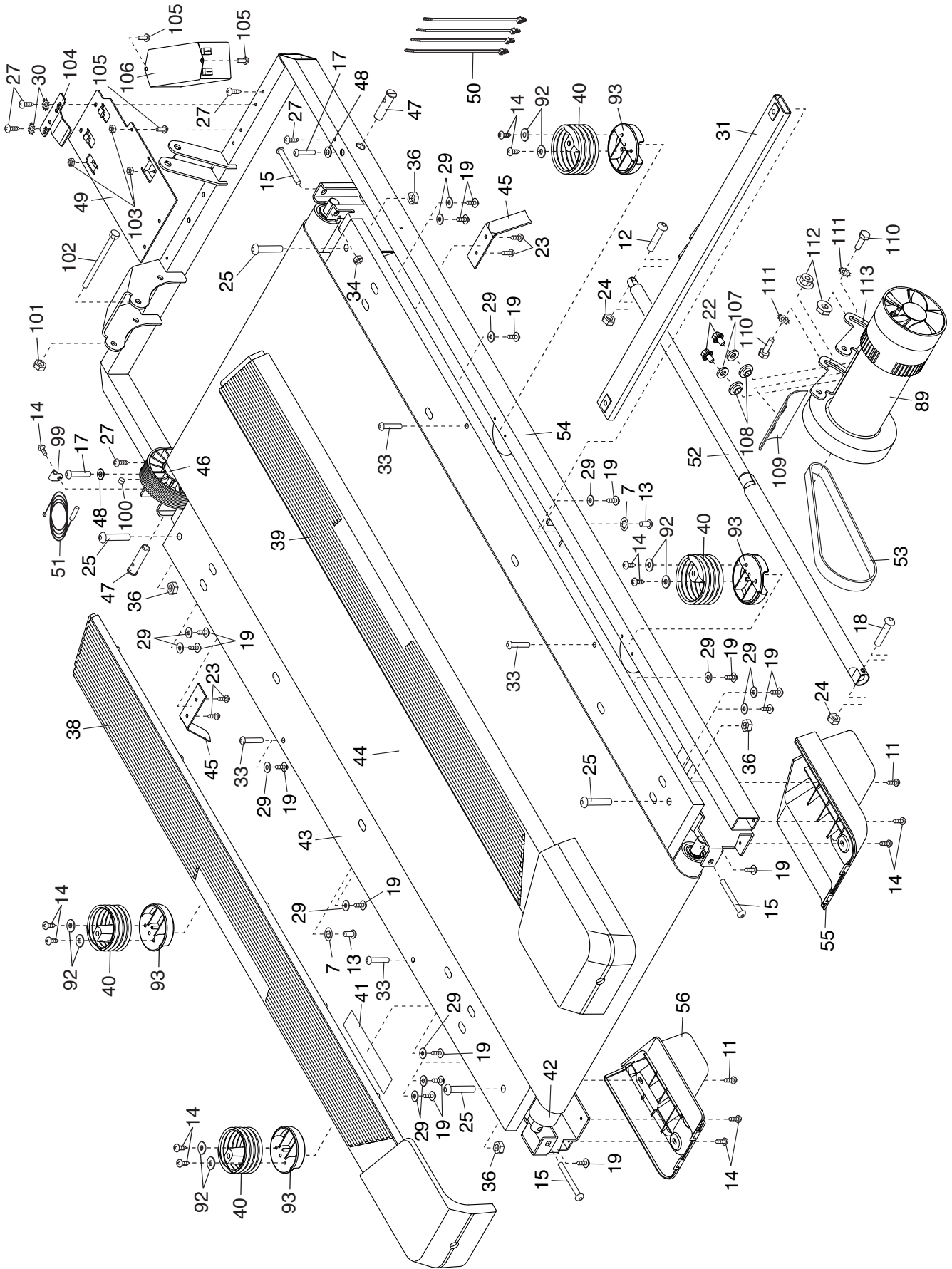

EXPLODED DRAWING B

Model No. PETL59819.0 R0919A

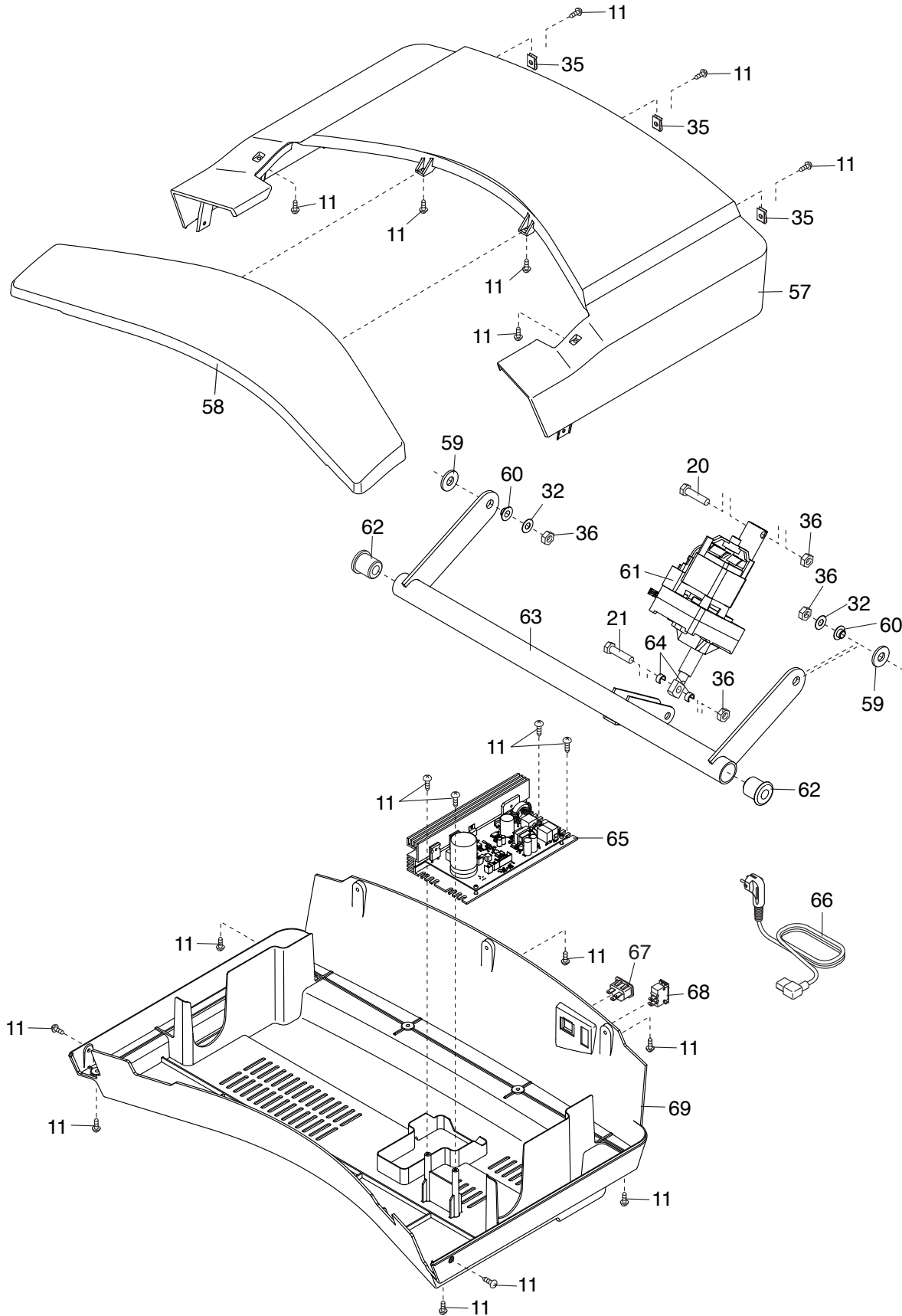

EXPLODED DRAWING C

Model No. PETL59819.0 R0919A

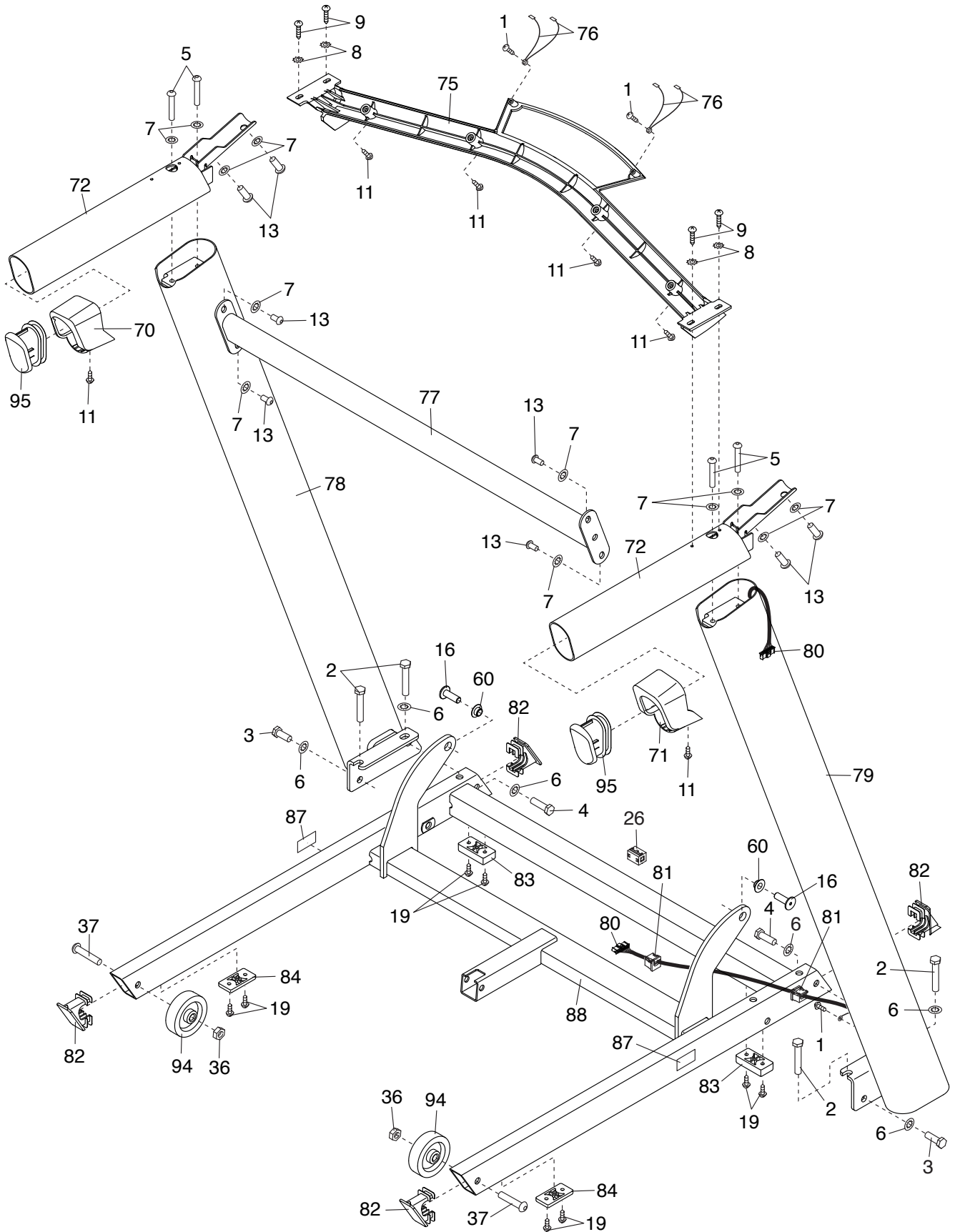

EXPLODED DRAWING D

Model No. PETL59819.0 R0919A

