

# EXPLODED DRAWING A

Model No. PETL59916.1 R0316A

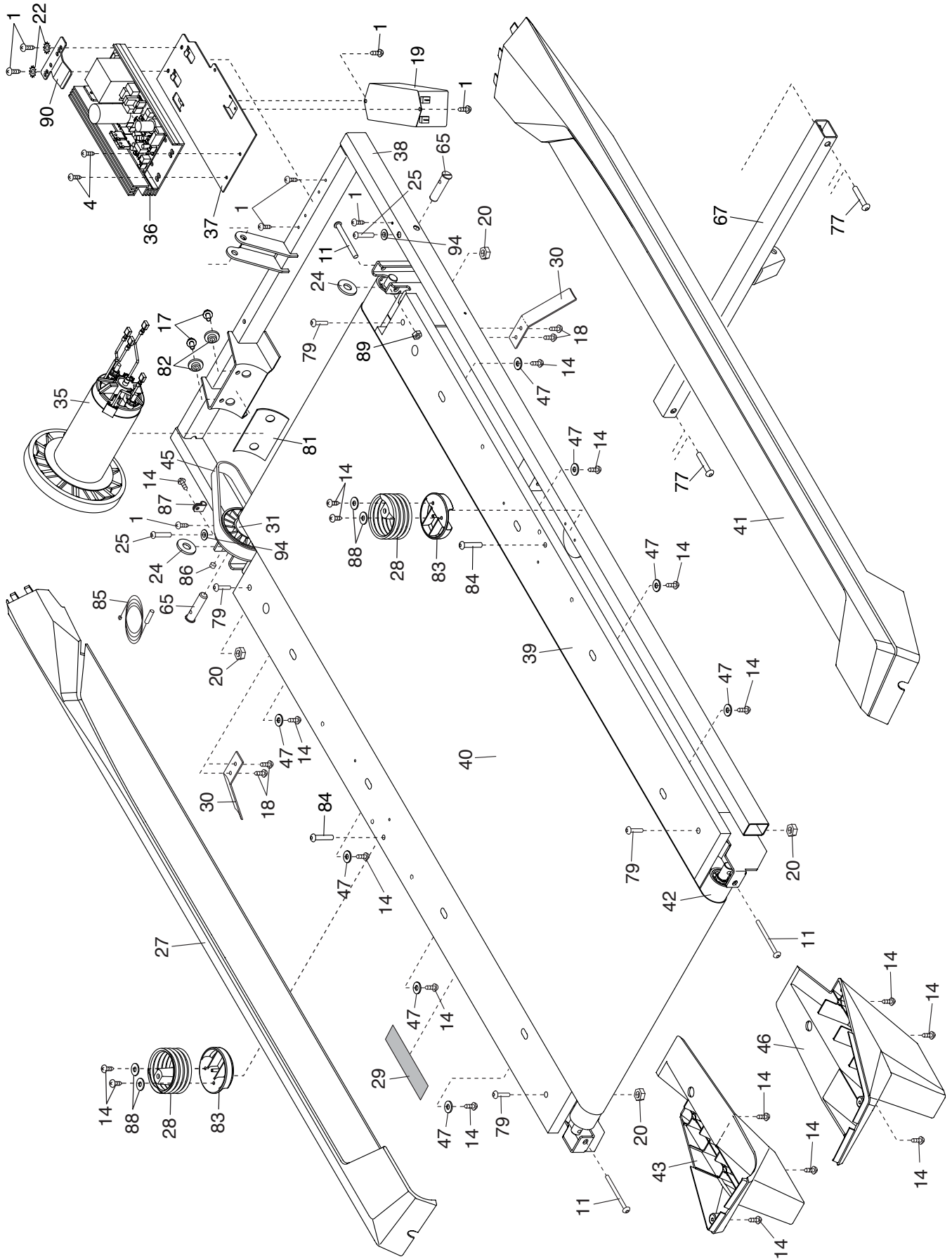

# EXPLODED DRAWING B

Model No. PETL59916.1 R0316A

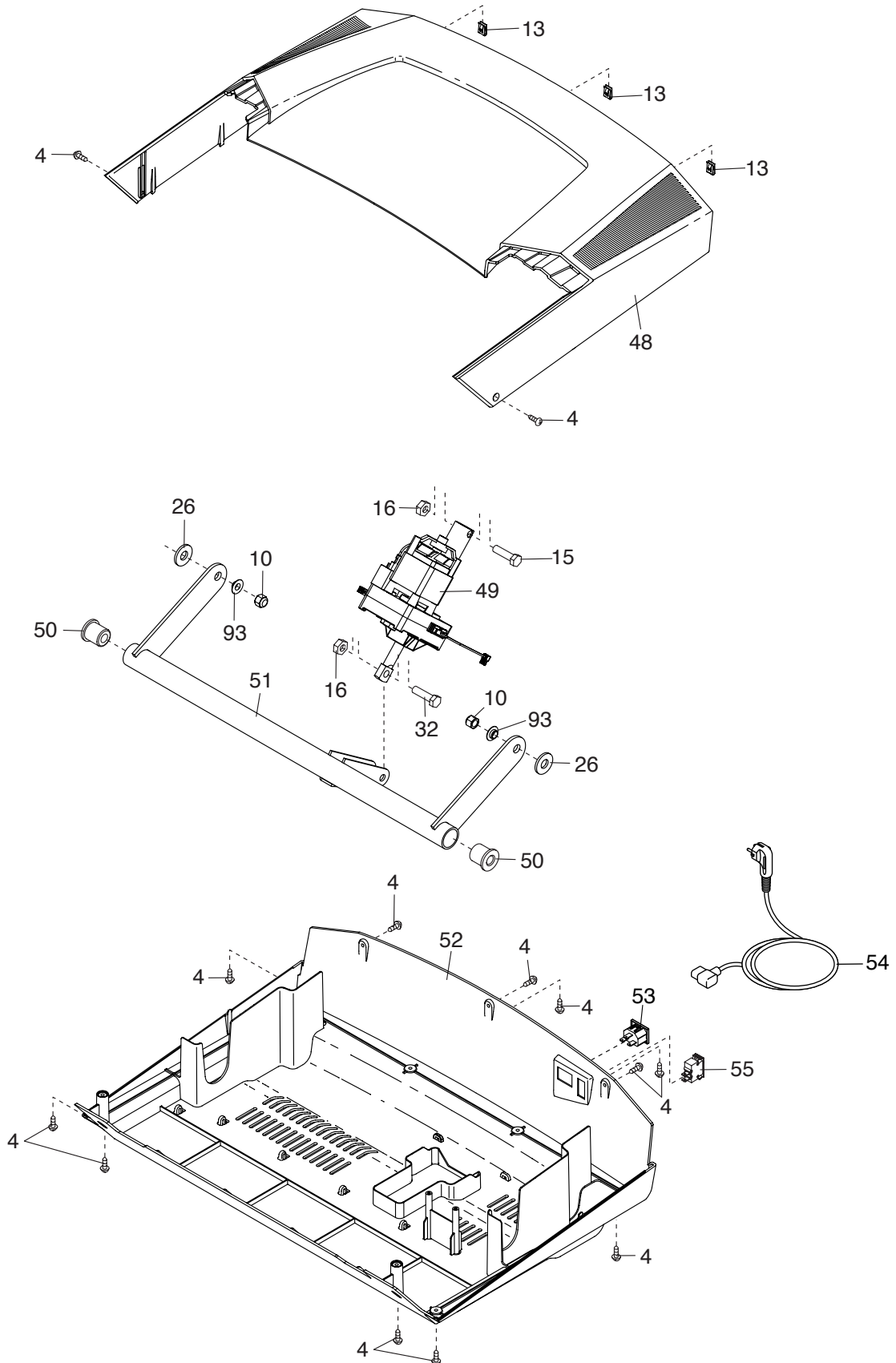

# EXPLODED DRAWING C

Model No. PETL59916.1 R0316A

