

EXPLODED DRAWING A

Model No. PETL69911.0 R0512A

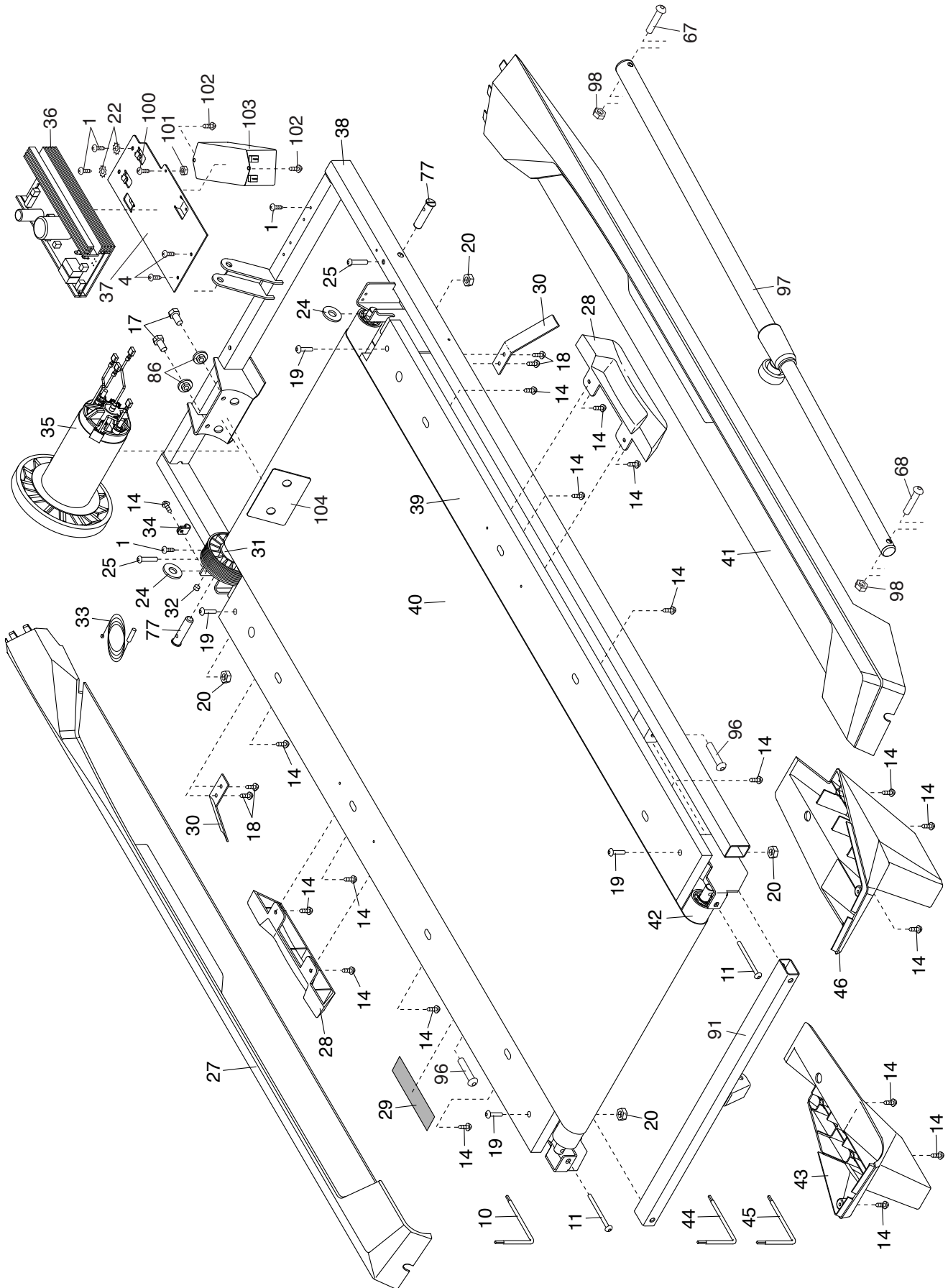

EXPLODED DRAWING B

Model No. PETL69911.0 R0512A

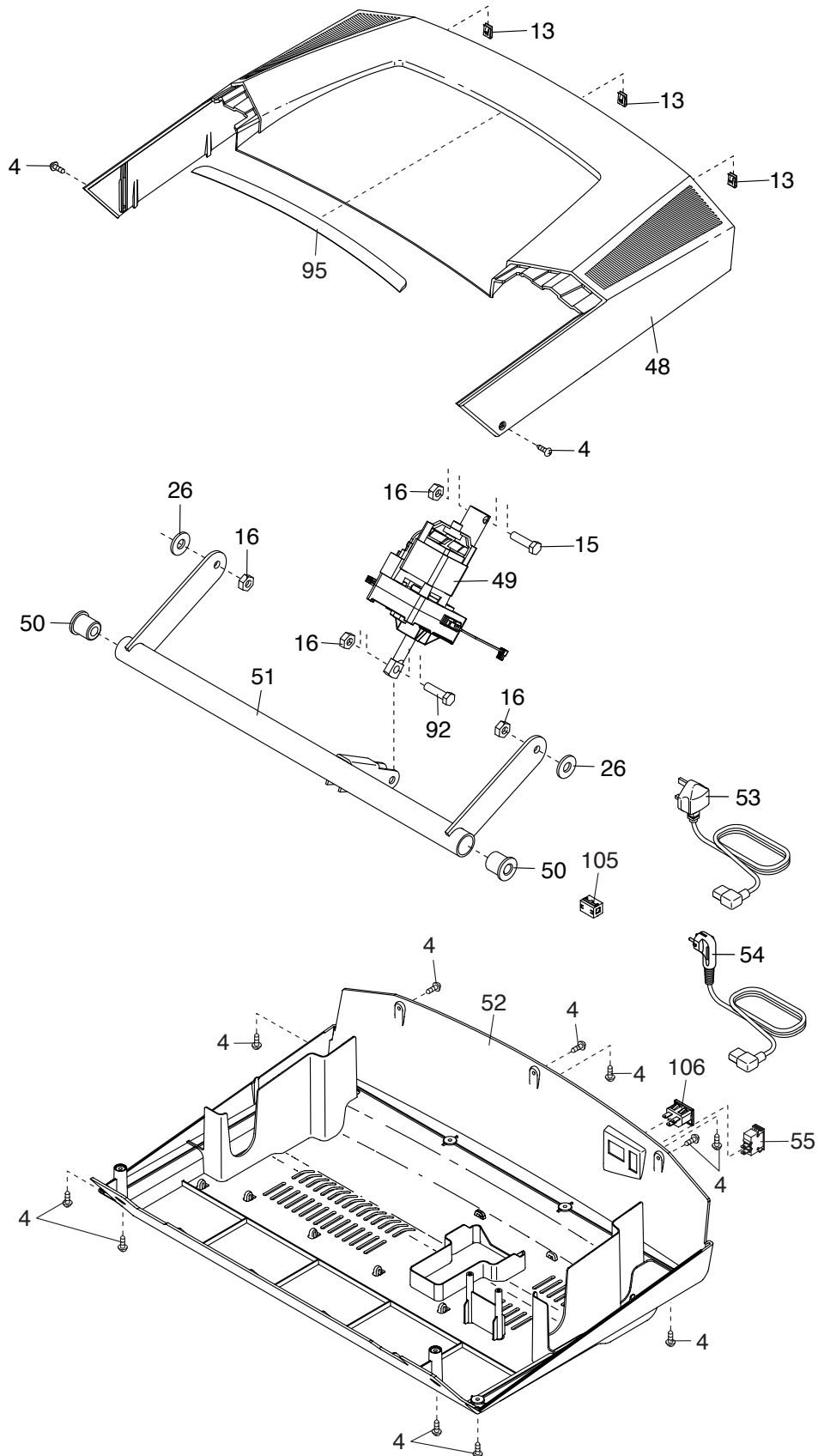

EXPLODED DRAWING C

Model No. PETL69911.0 R0512A

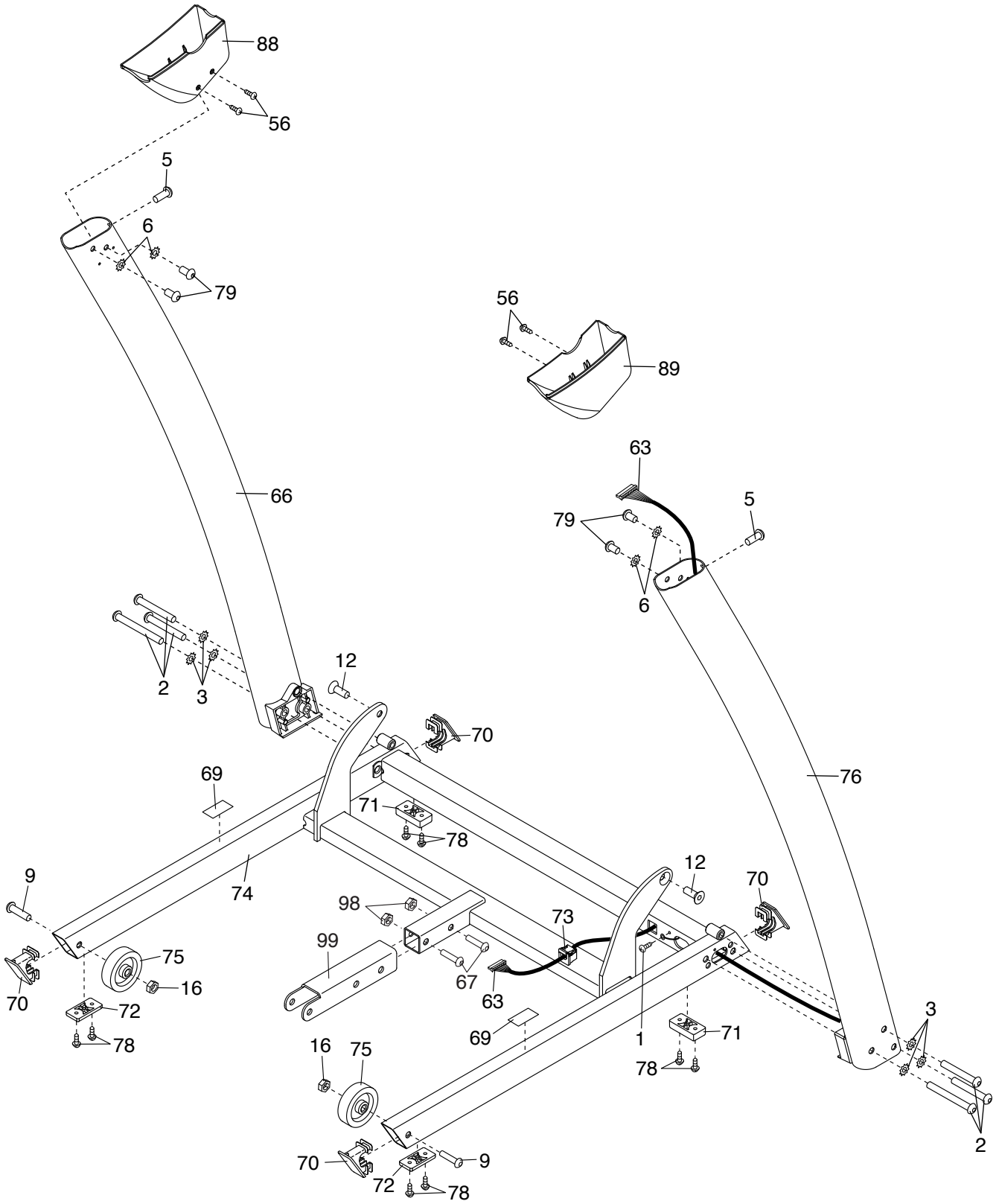

EXPLODED DRAWING D

Model No. PETL69911.0 R0512A

