

# EXPLODED DRAWING A

Model No. PETL69911.1 R0314A

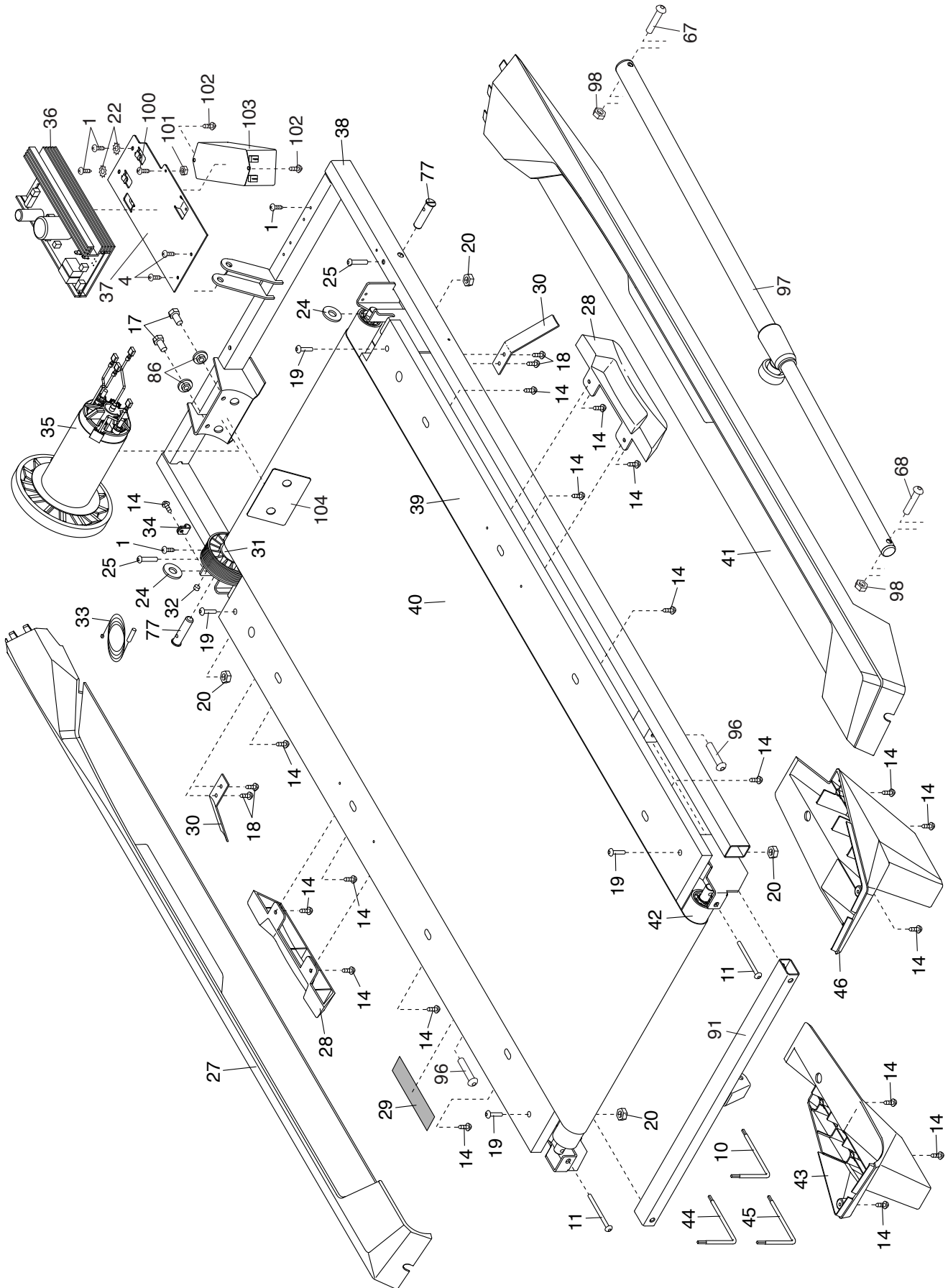

# EXPLODED DRAWING B

Model No. PETL69911.1 R0314A

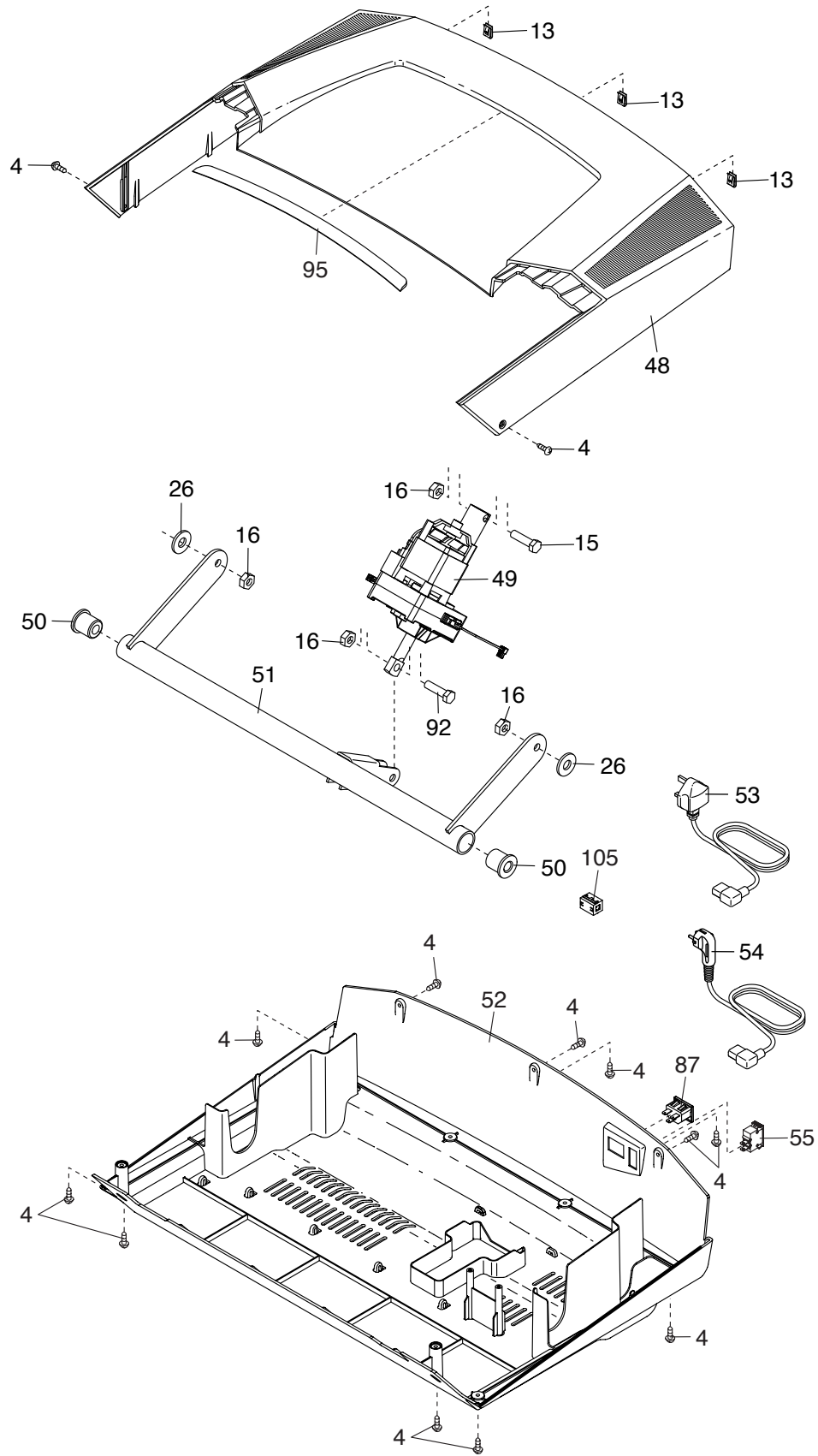

# EXPLODED DRAWING C

Model No. PETL69911.1 R0314A

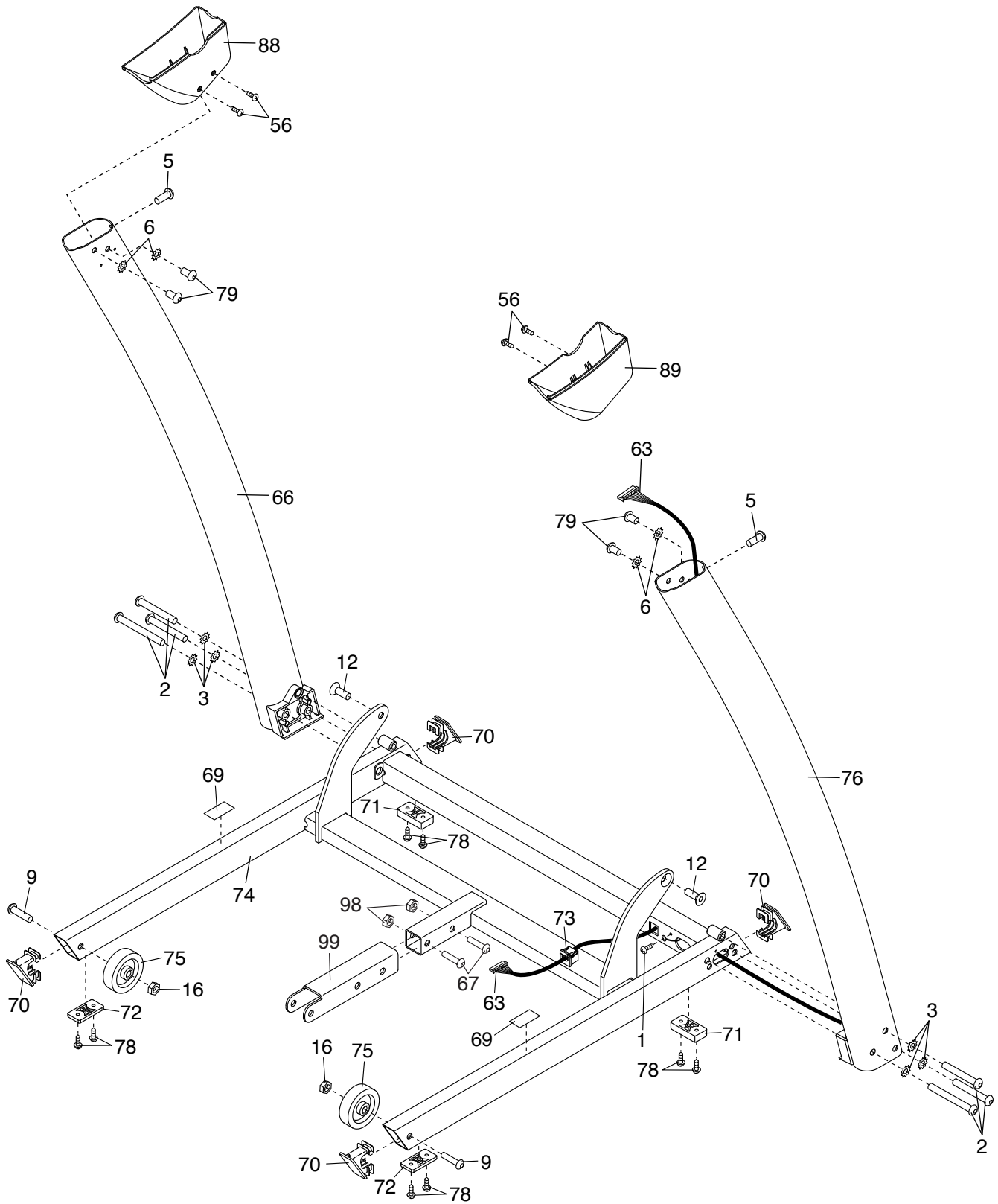

# EXPLODED DRAWING D

Model No. PETL69911.1 R0314A

