

# EXPLODED DRAWING A—Model No. PETL70707.2

R0709A

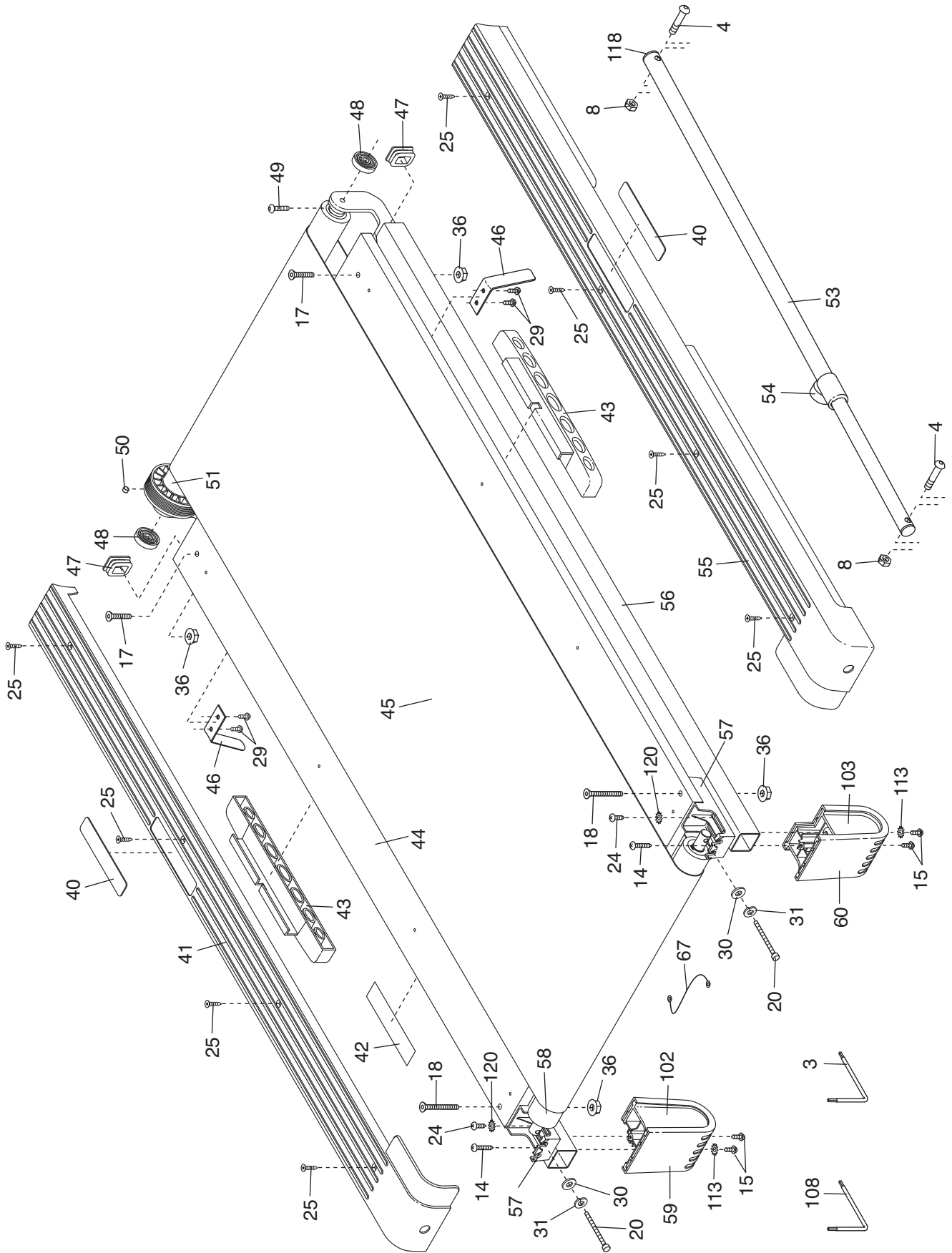

# EXPLODED DRAWING B—Model No. PETL70707.2

R0709A

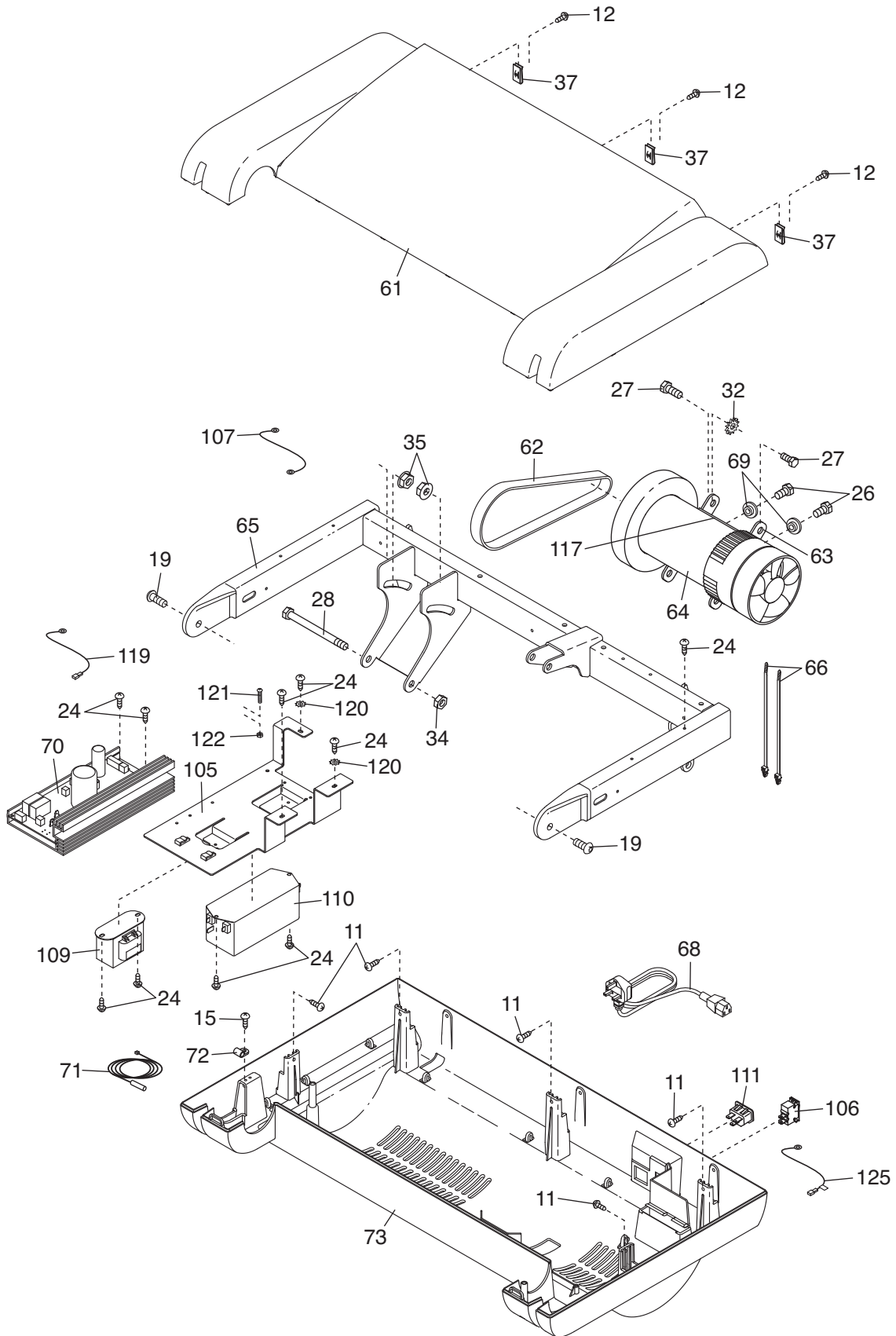

# EXPLODED DRAWING C—Model No. PETL70707.2

R0709A

