

# EXPLODED DRAWING A—Model No. PETL71707.0

R1207A

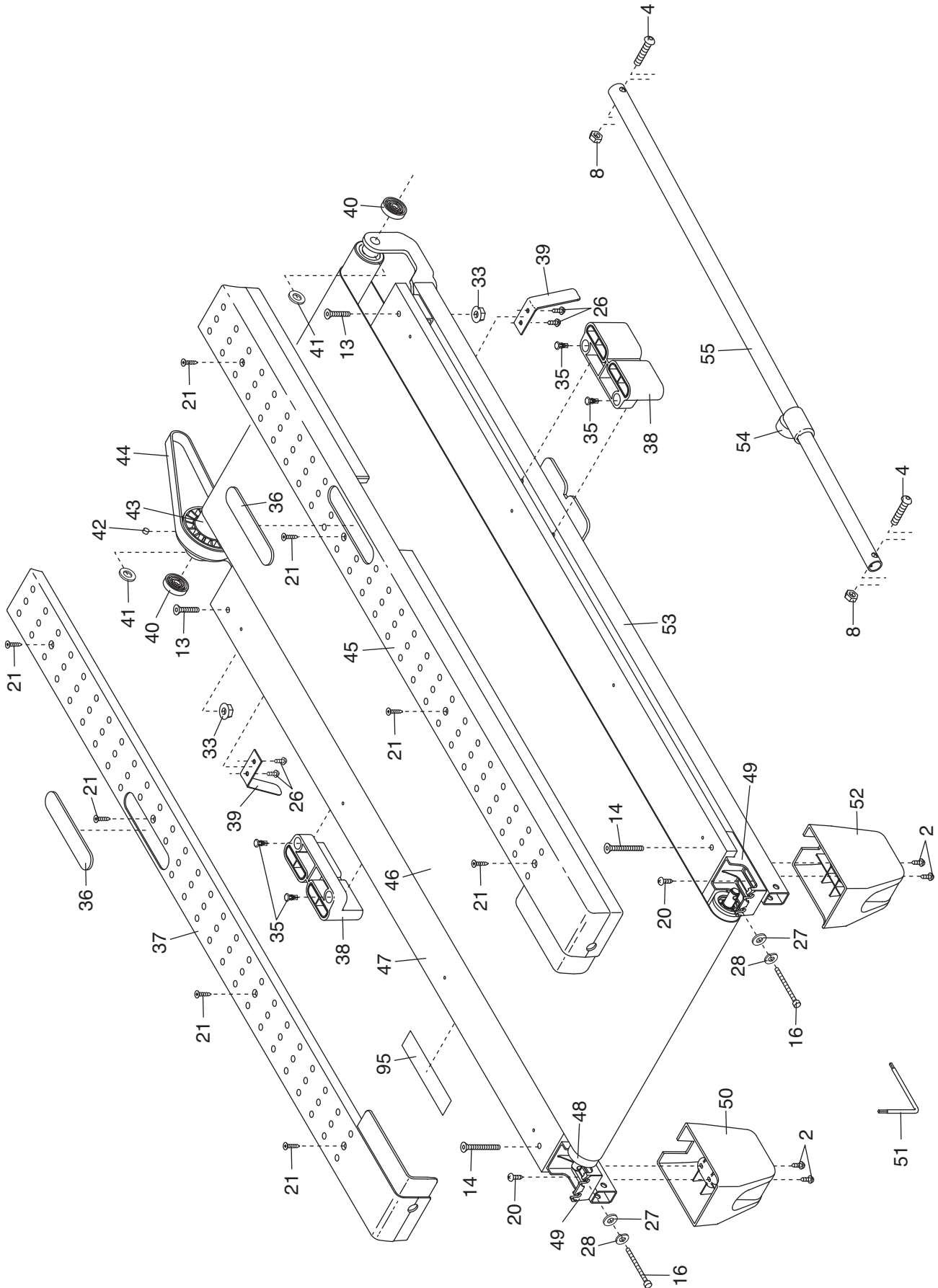

# EXPLODED DRAWING B—Model No. PETL71707.0

R1207A

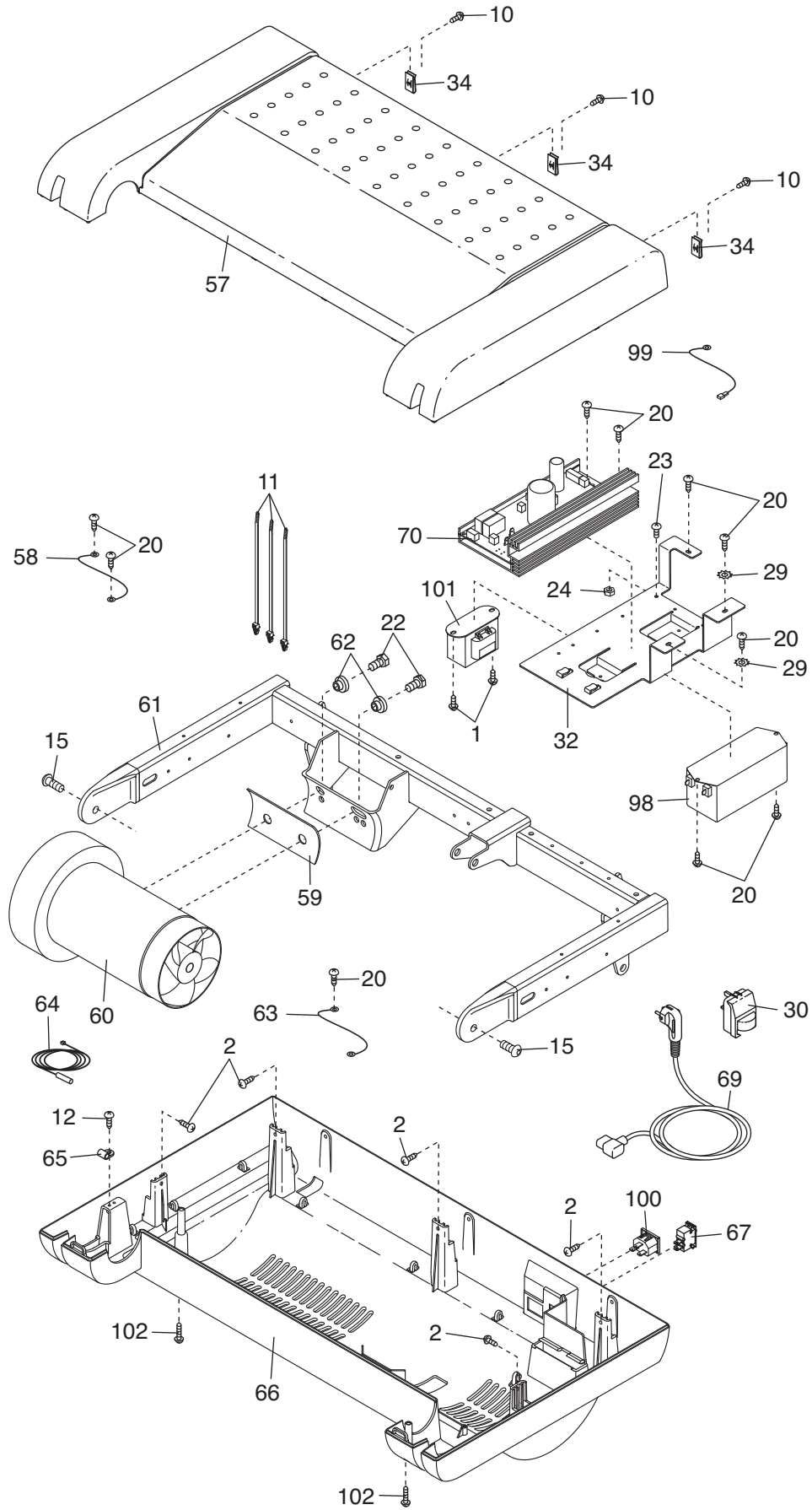

# EXPLODED DRAWING C—Model No. PETL71707.0

R1207A

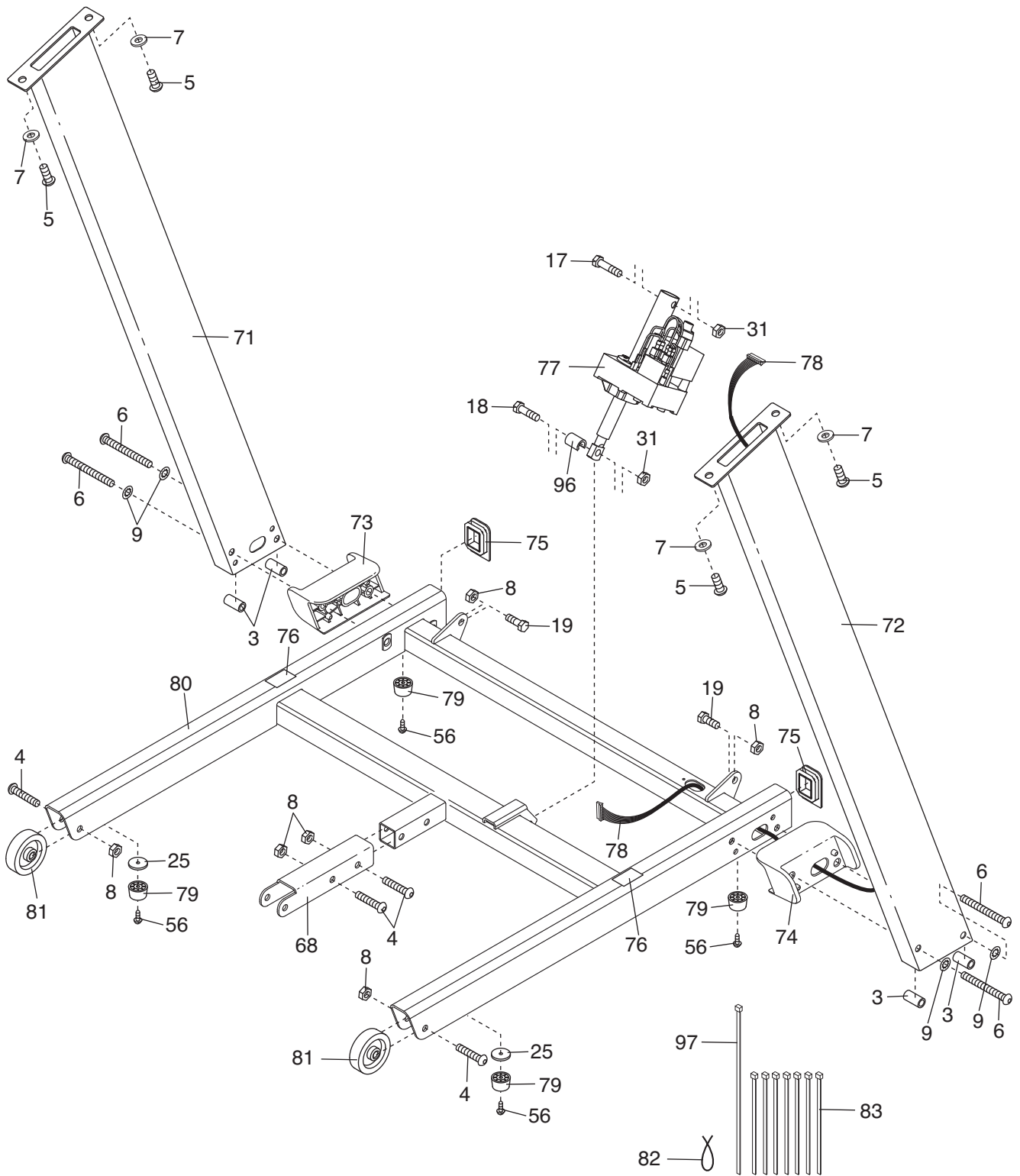

# EXPLODED DRAWING D—Model No. PETL71707.0

R1207A

