

EXPLODED DRAWING A—Model No. PETL71707.2

R0209A

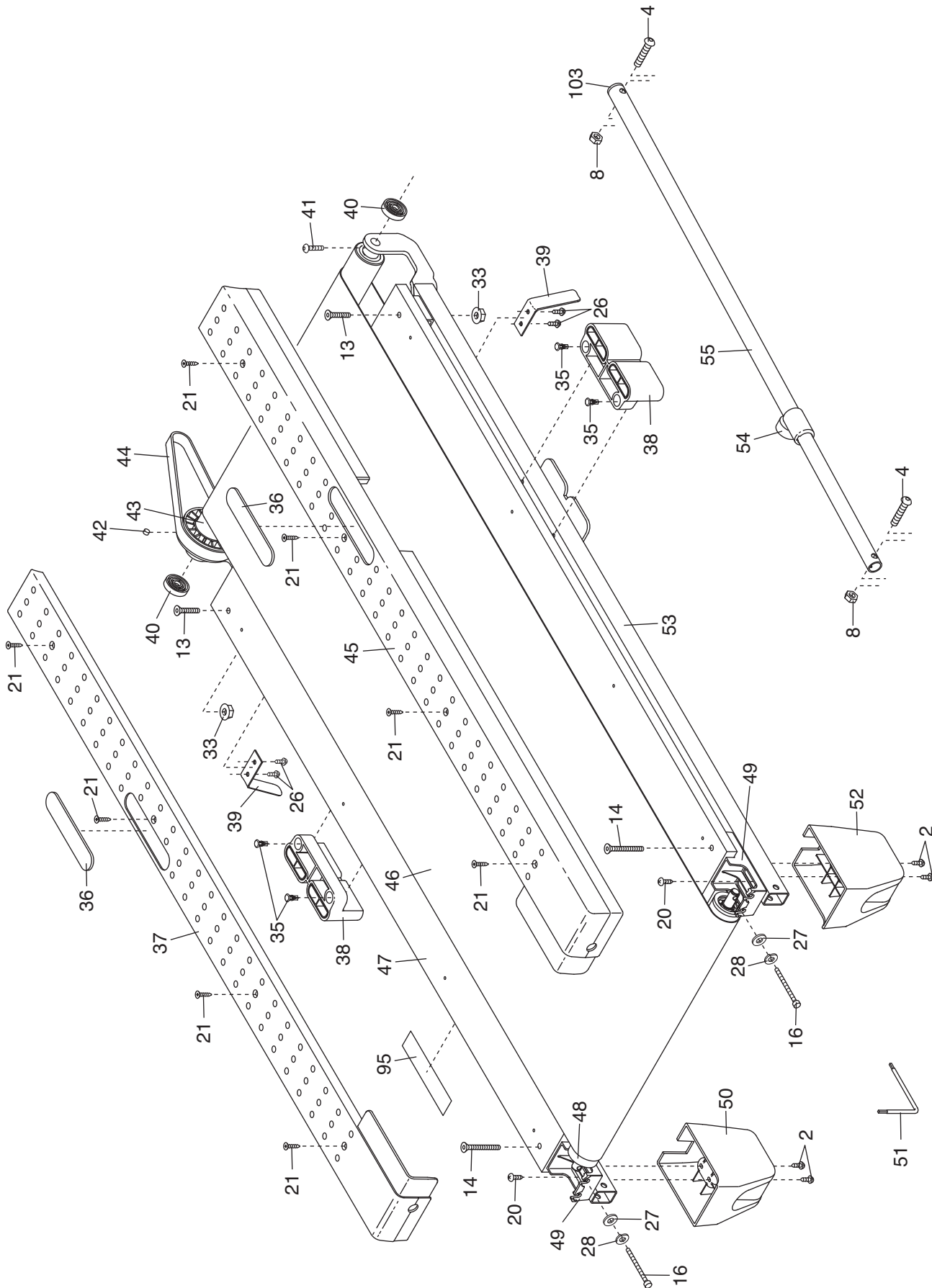

EXPLODED DRAWING B—Model No. PETL71707.2

R0209A

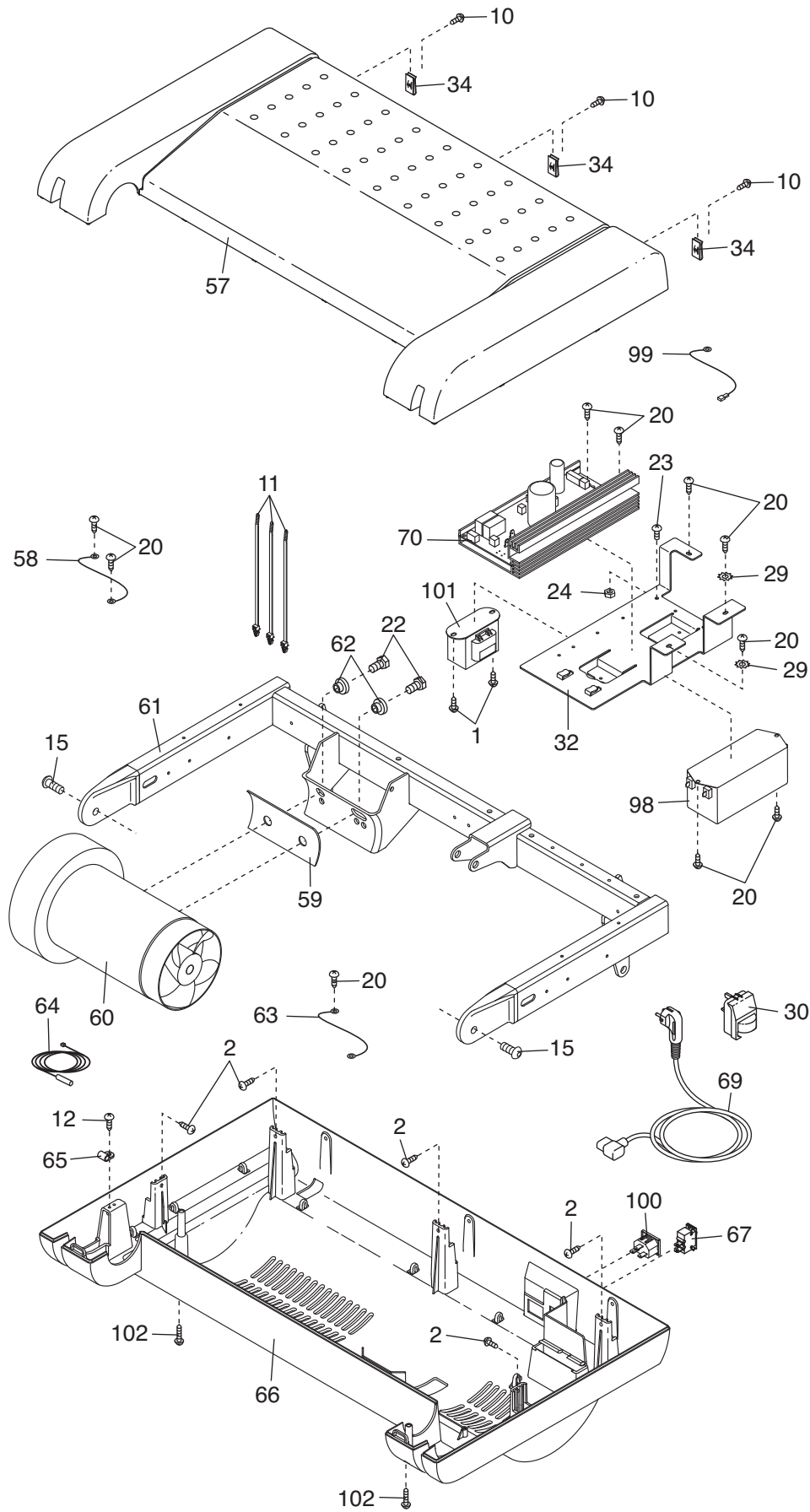

EXPLODED DRAWING C—Model No. PETL71707.2

R0209A

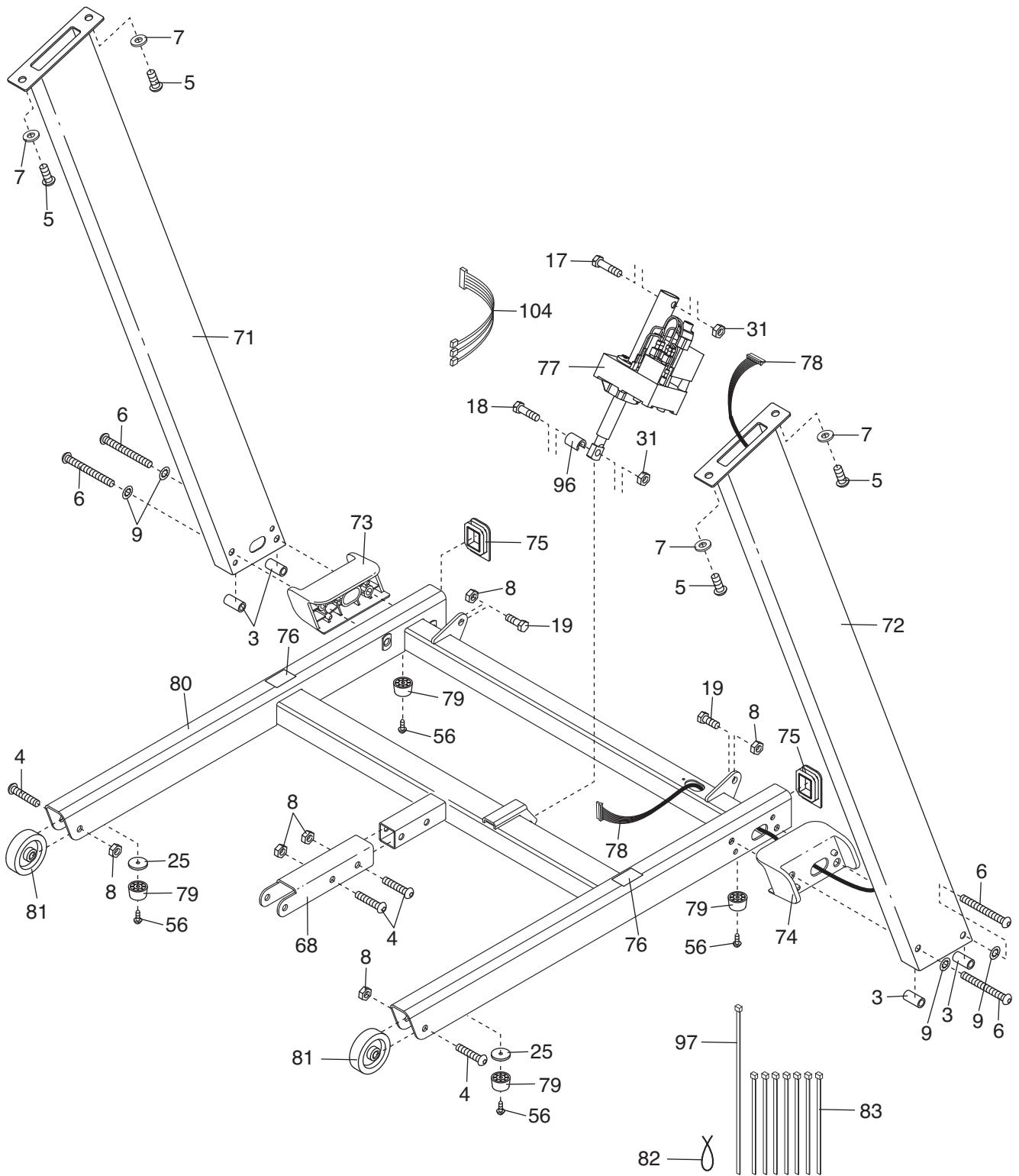

EXPLODED DRAWING D—Model No. PETL71707.2

R0209A

