

EXPLODED DRAWING A

Model No. PETL79713.1 R0414A

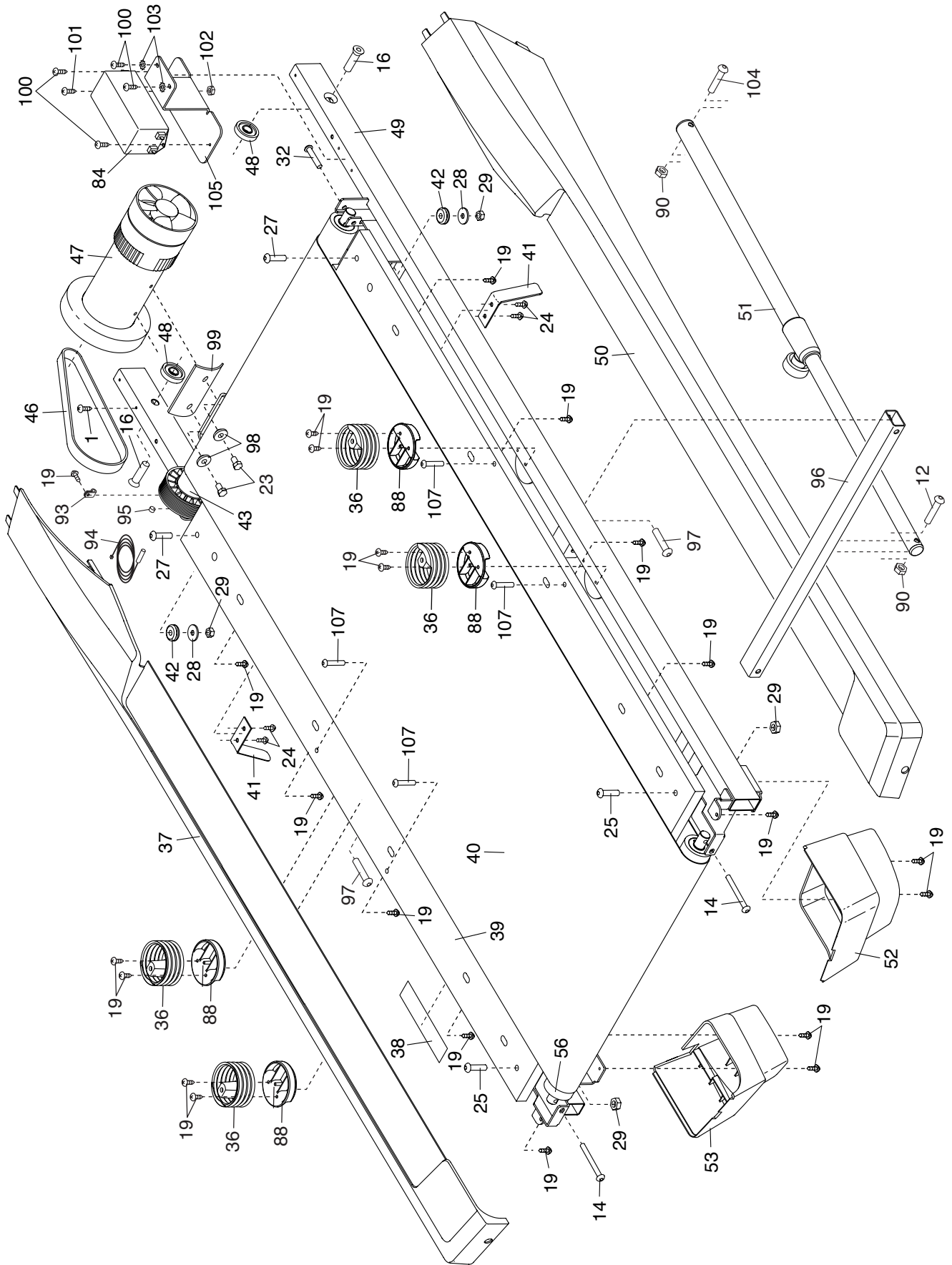

EXPLODED DRAWING B

Model No. PETL79713.1 R0414A

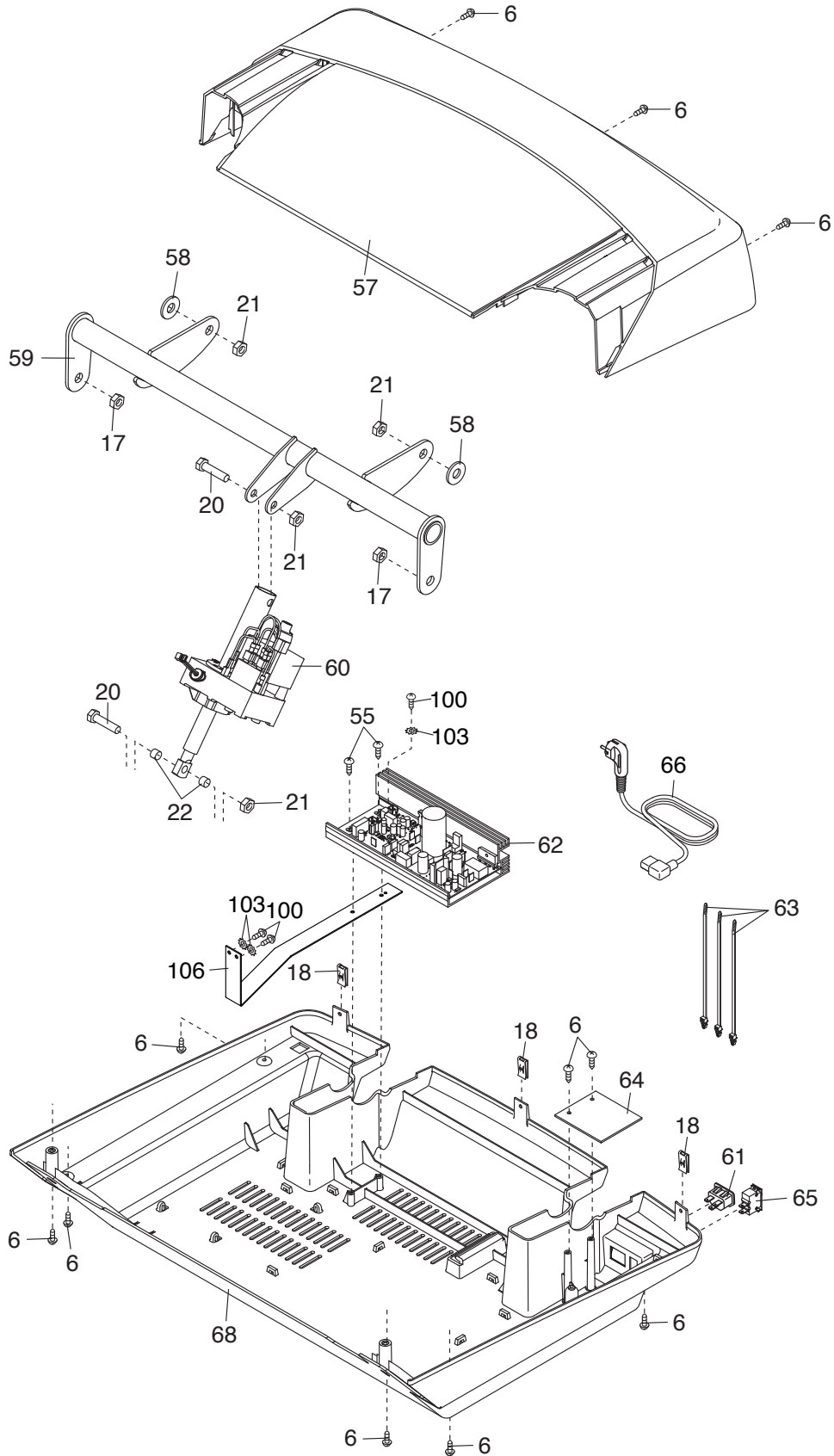

EXPLODED DRAWING C

Model No. PETL79713.1 R0414A

