

EXPLODED DRAWING A

Model No. PETL79714.0 R0314A

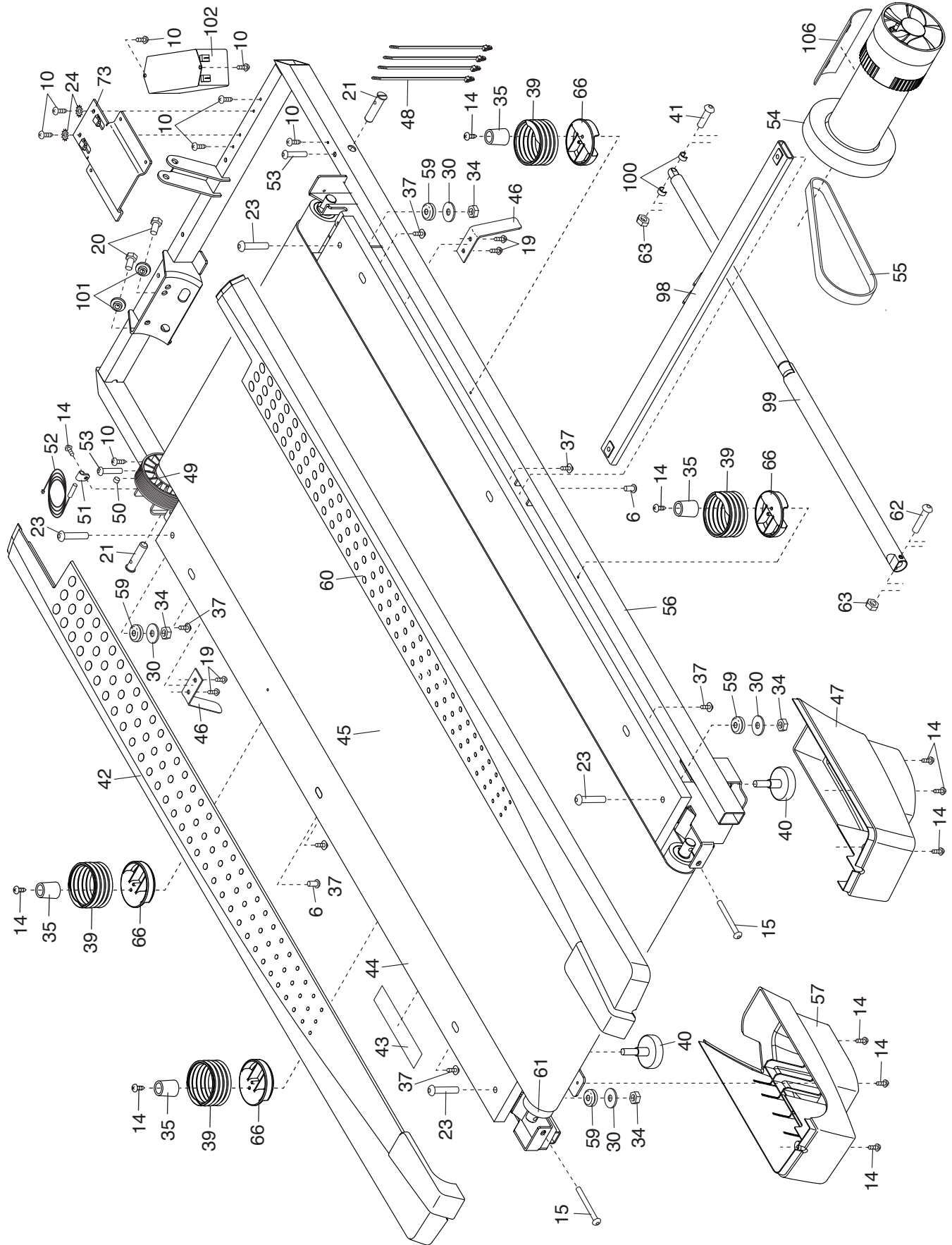

EXPLODED DRAWING B

Model No. PETL79714.0 R0314A

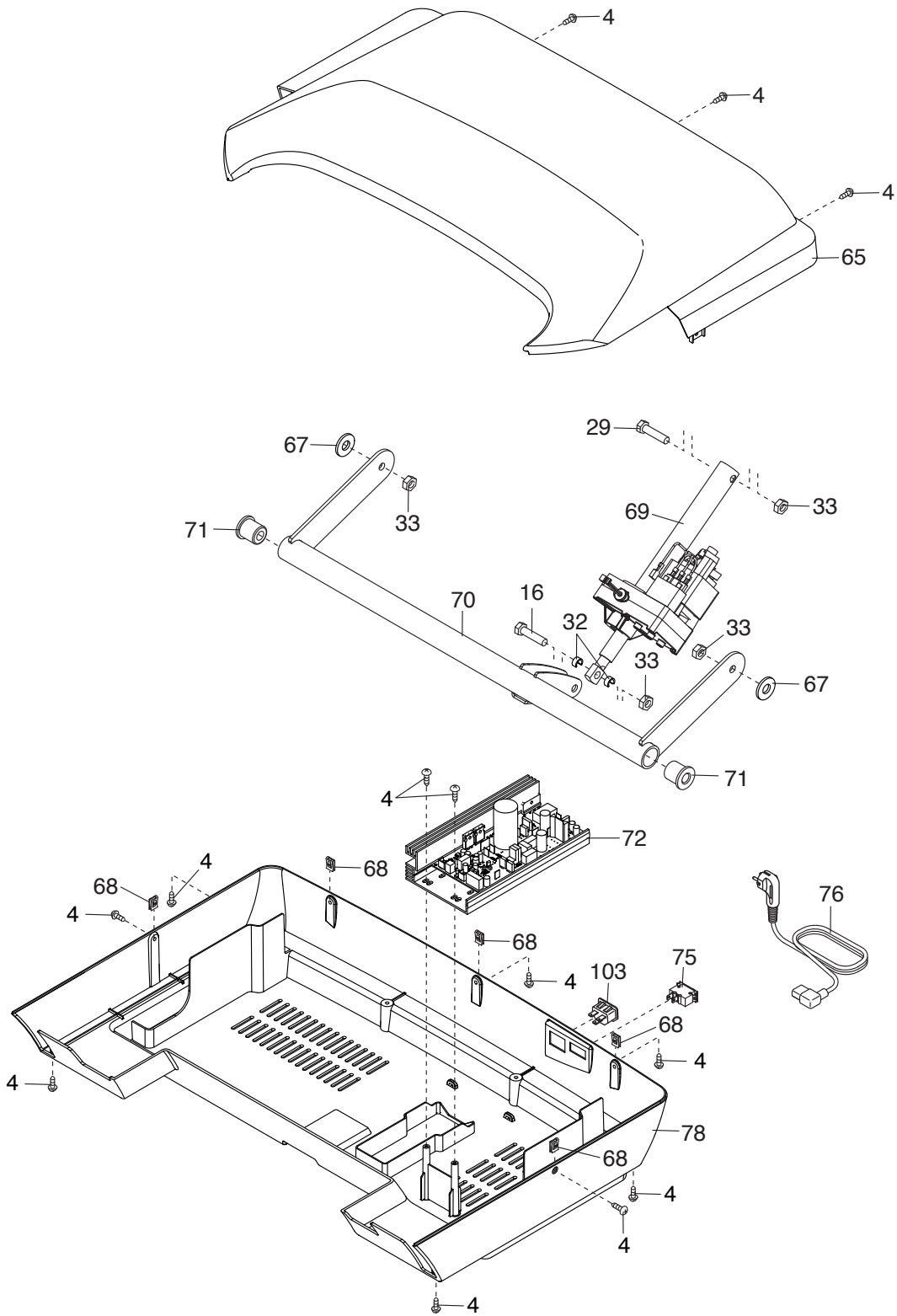

EXPLODED DRAWING C

Model No. PETL79714.0 R0314A

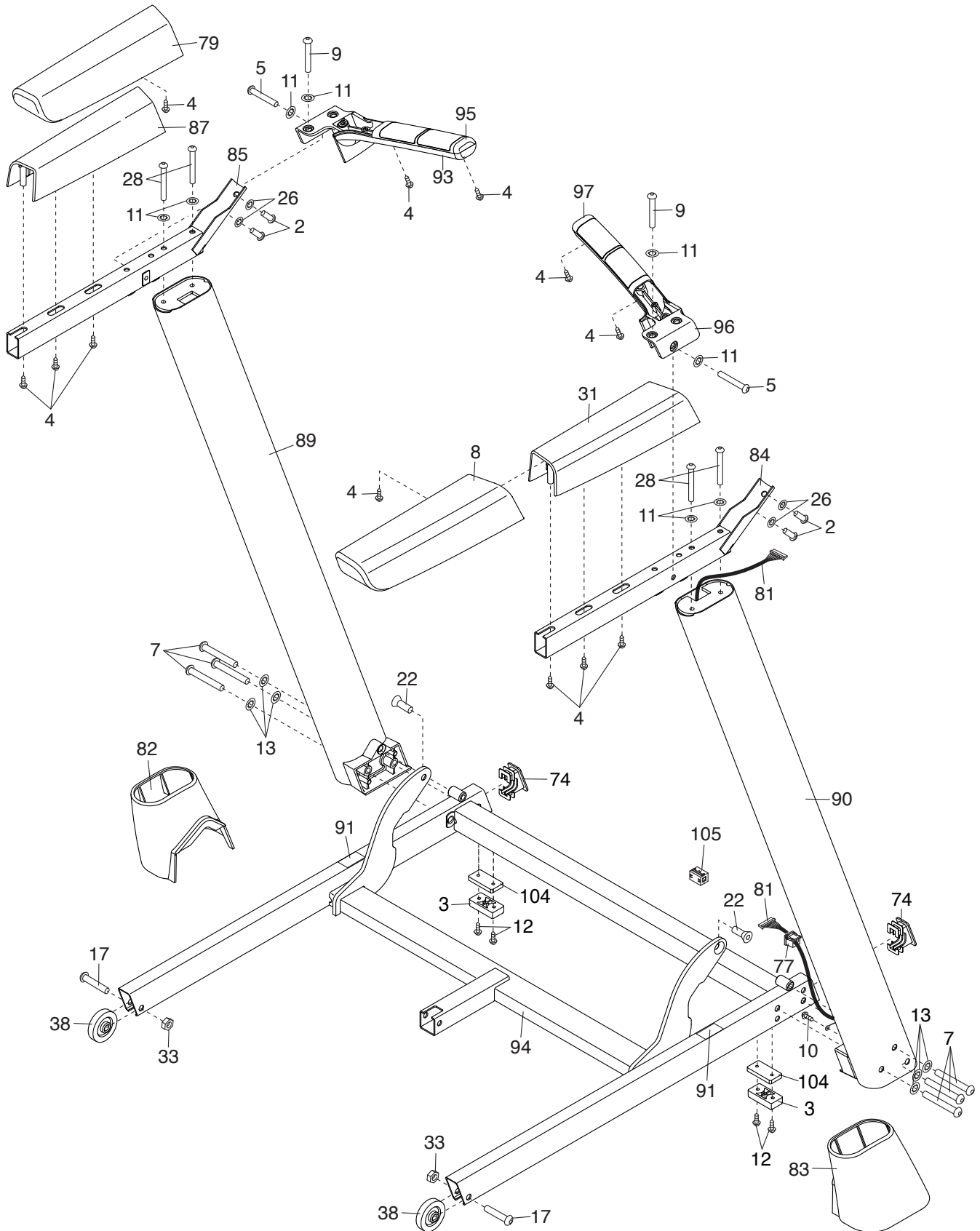

EXPLODED DRAWING D

Model No. PETL79714.0 R0314A

