

# EXPLODED DRAWING A

Model No. PETL79714.3 R1114A

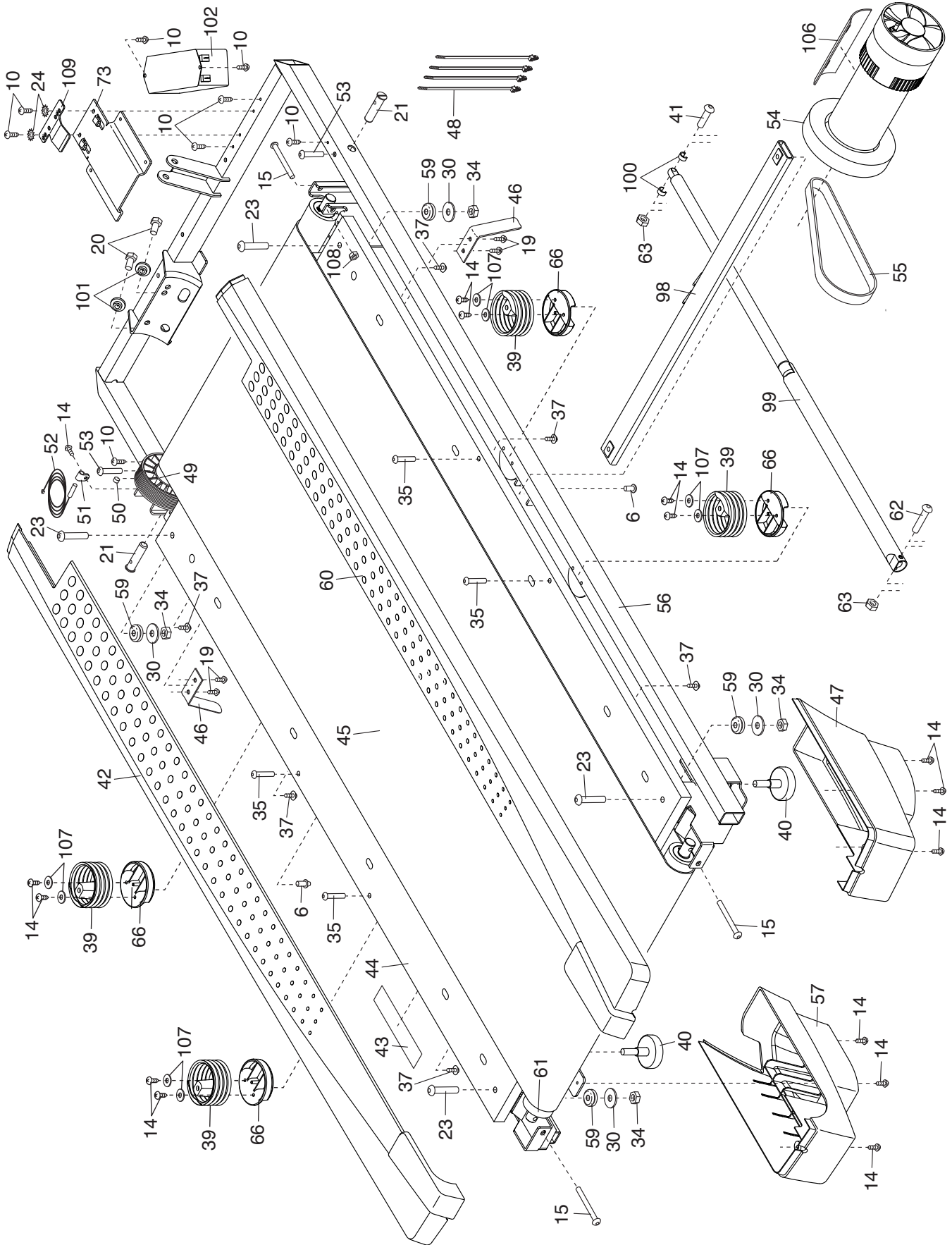

# EXPLODED DRAWING B

Model No. PETL79714.3 R1114A

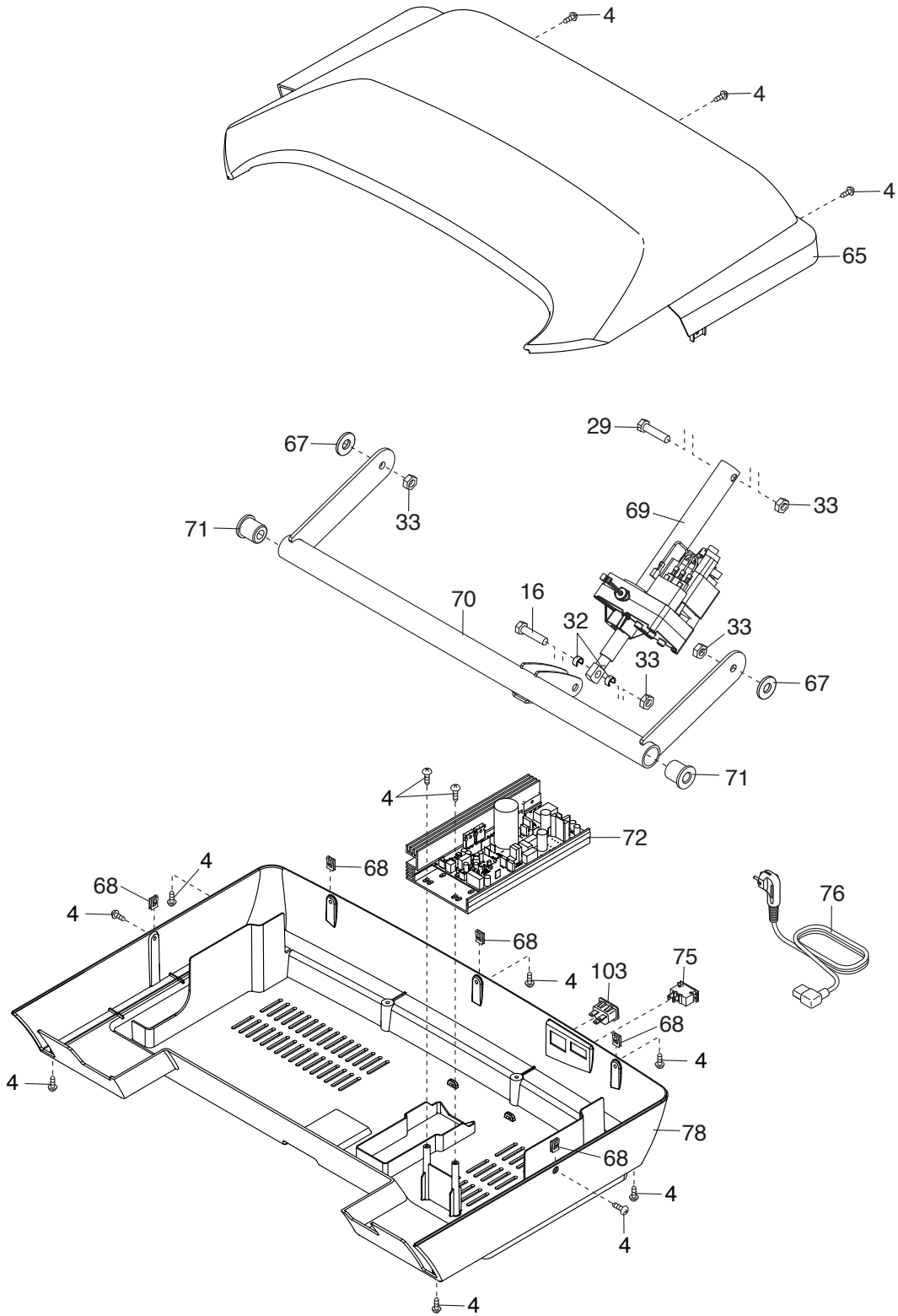

# EXPLODED DRAWING C

Model No. PETL79714.3 R1114A

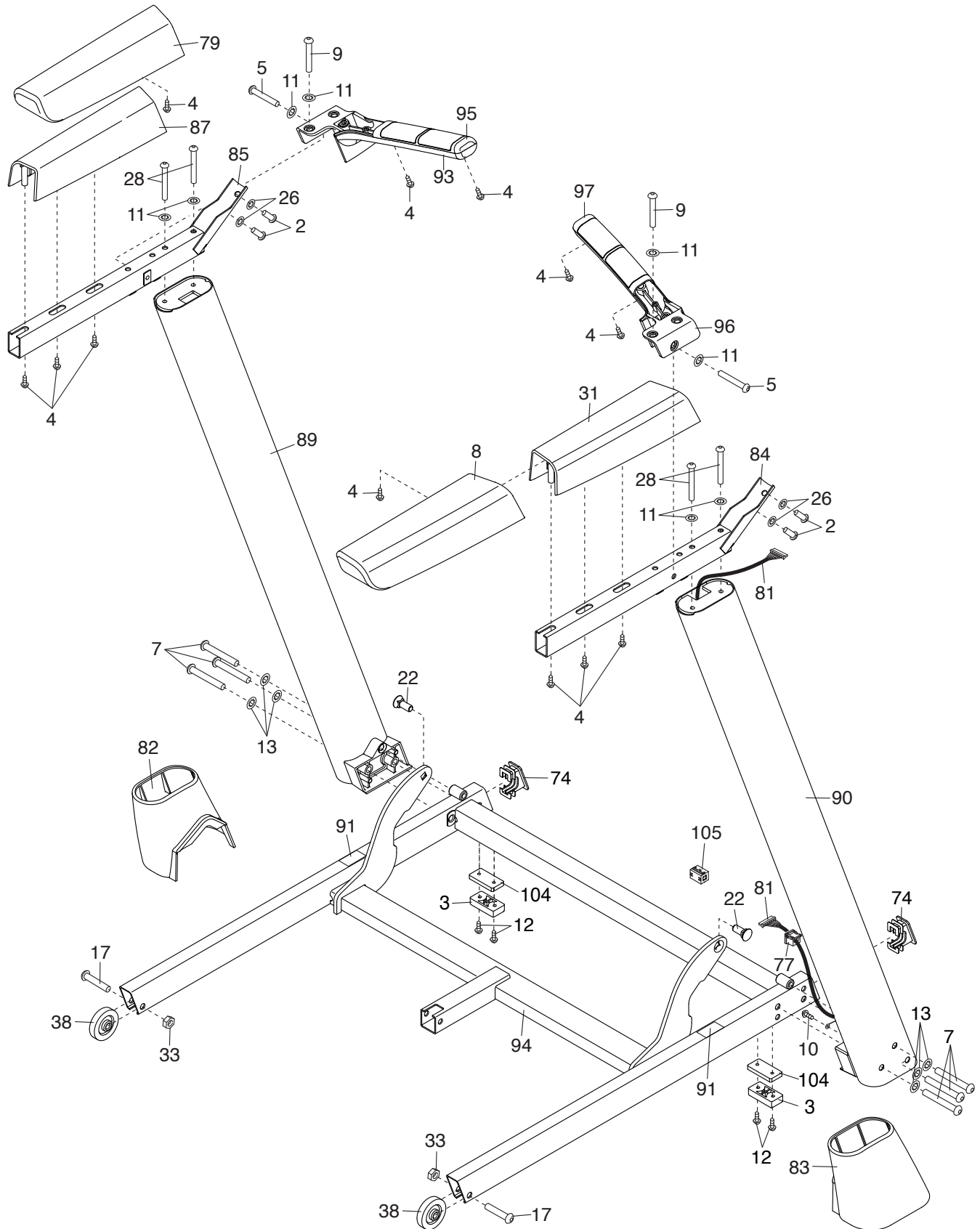

# EXPLODED DRAWING D

Model No. PETL79714.3 R1114A

