

EXPLODED DRAWING A

Model No. PETL79714.1 R0414A

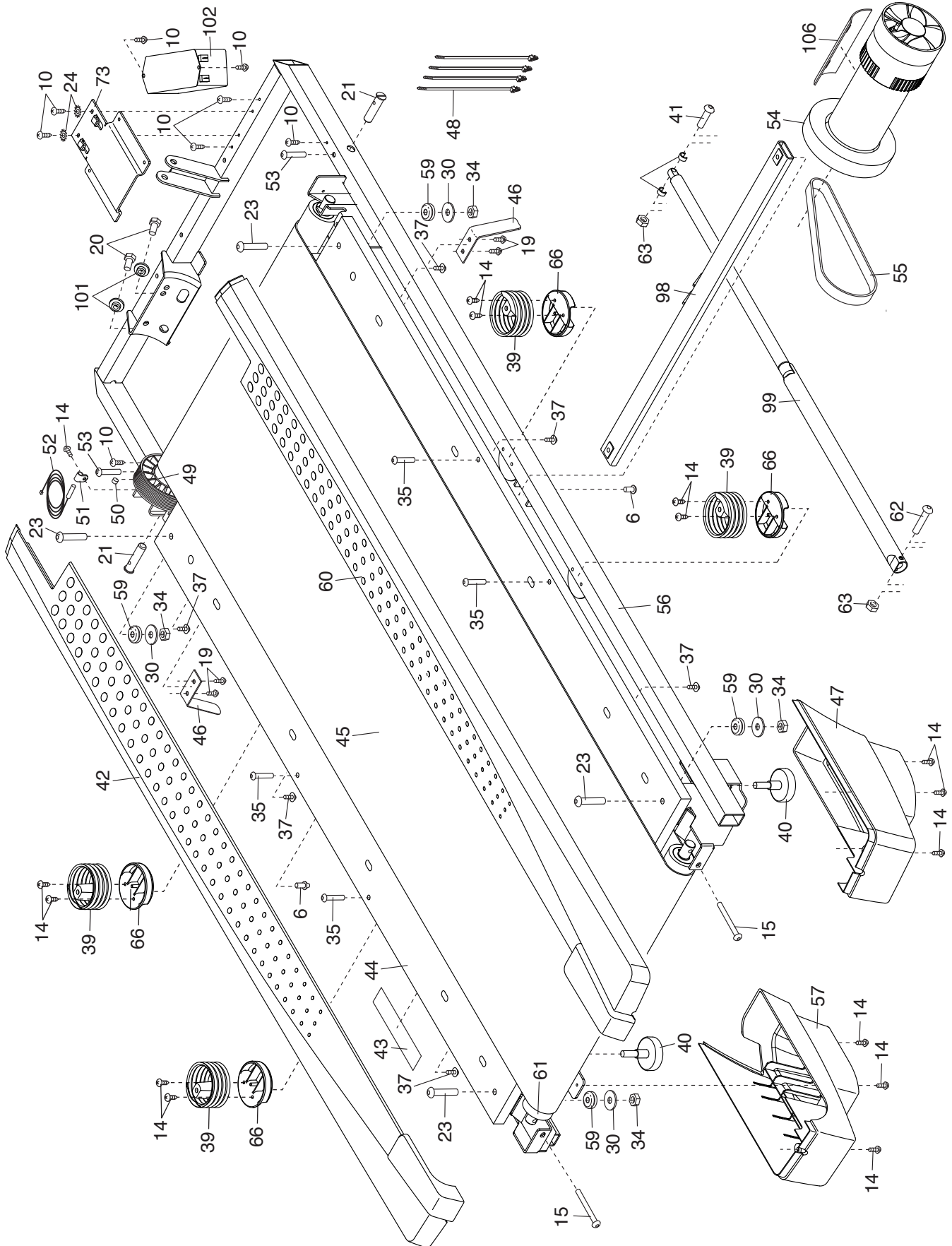

EXPLODED DRAWING B

Model No. PETL79714.1 R0414A

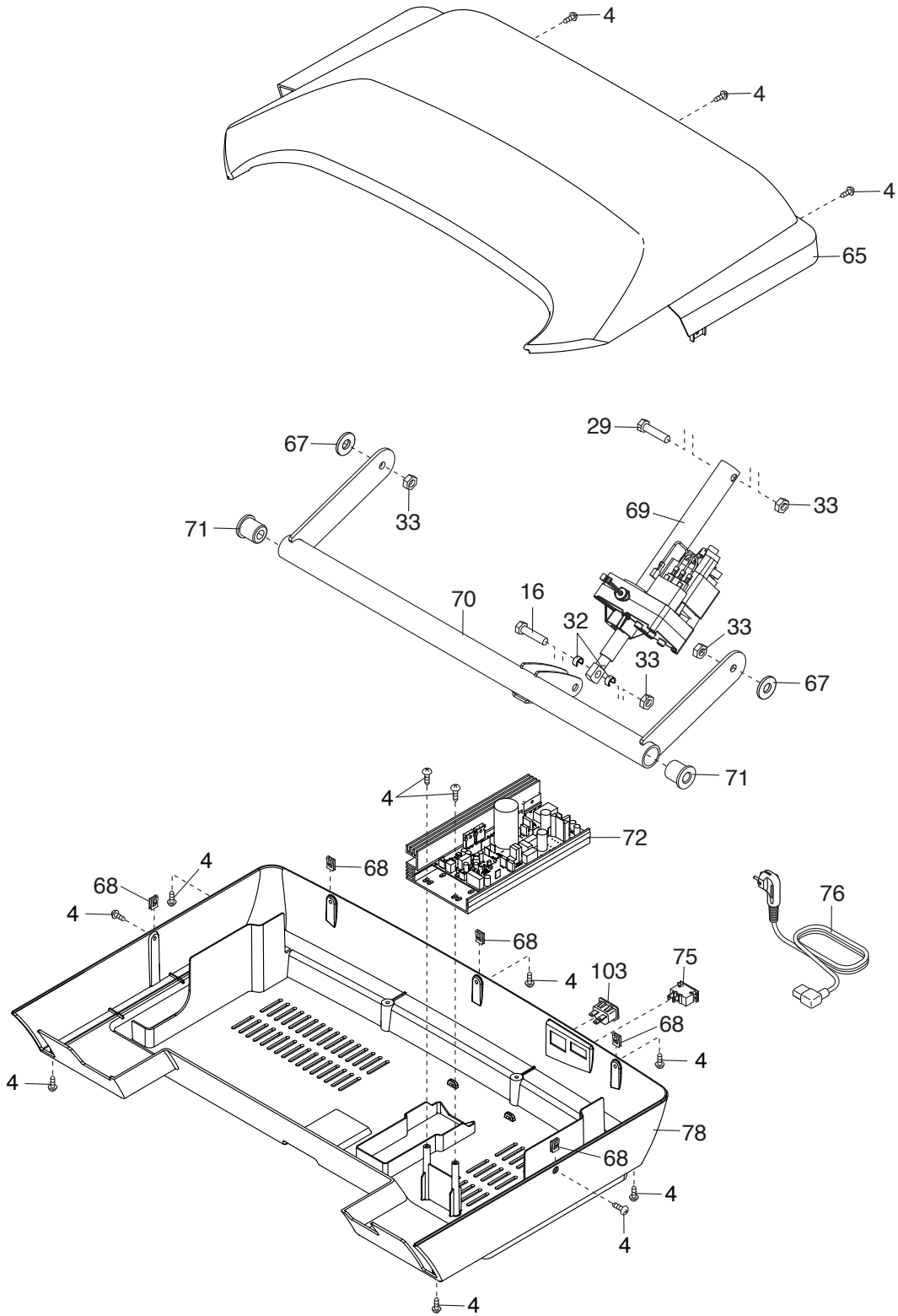

EXPLODED DRAWING D

Model No. PETL79714.1 R0414A

