

EXPLODED DRAWING A

Model No. PETL79816.0 R1016A

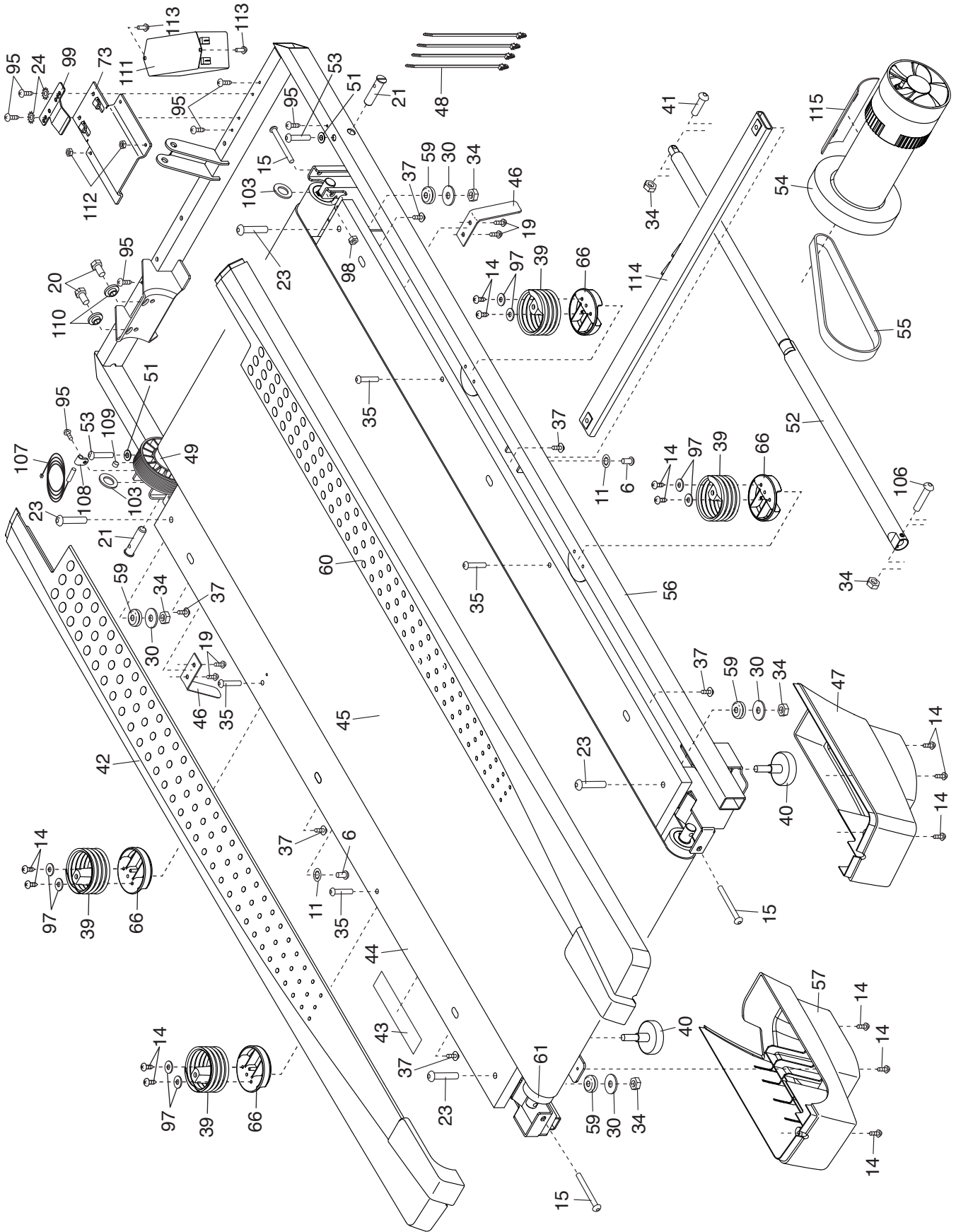

EXPLODED DRAWING B

Model No. PETL79816.0 R1016A

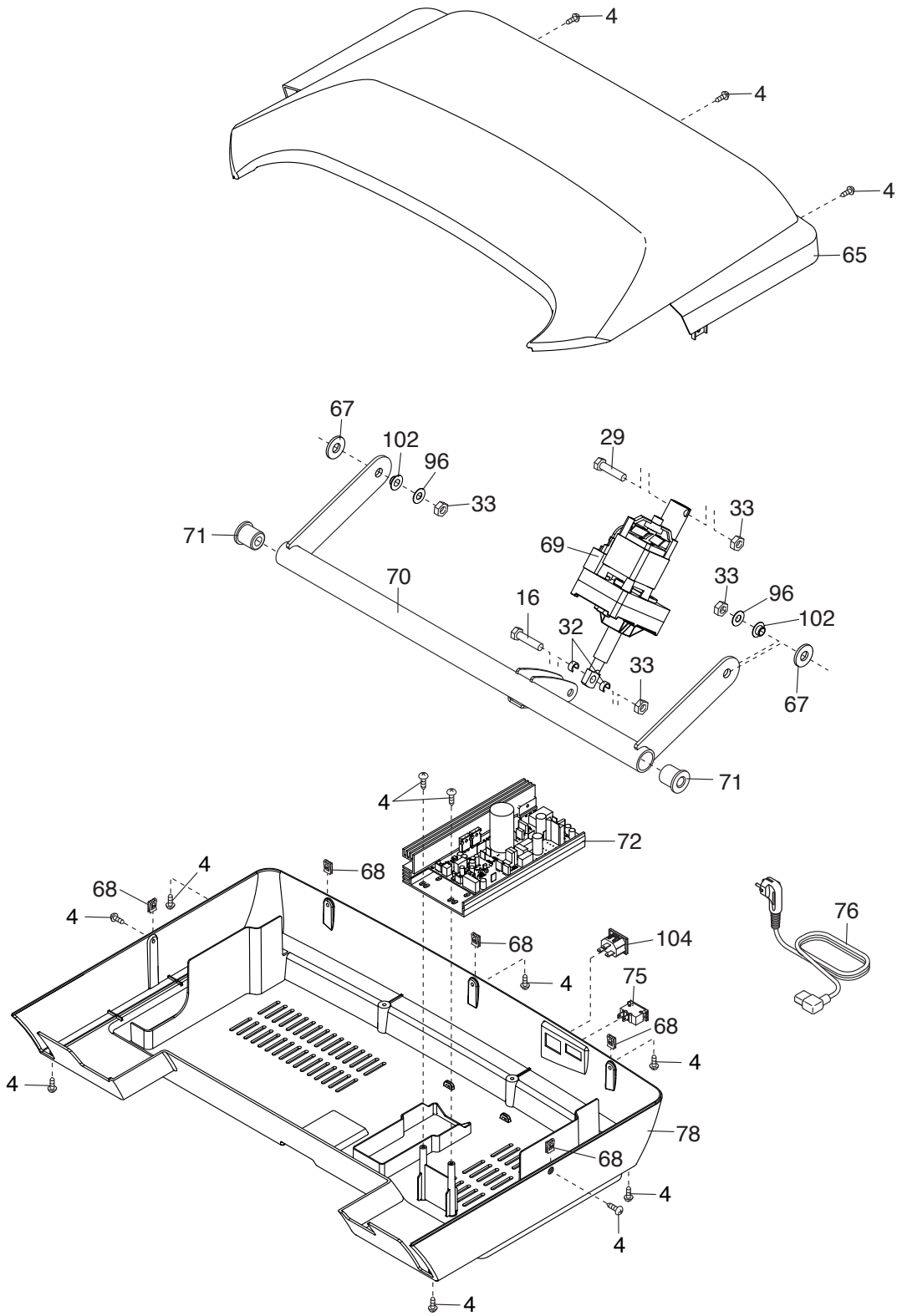

EXPLODED DRAWING D

Model No. PETL79816.0 R1016A

