

EXPLODED DRAWING A

Model No. PETL79816.2 R0917A

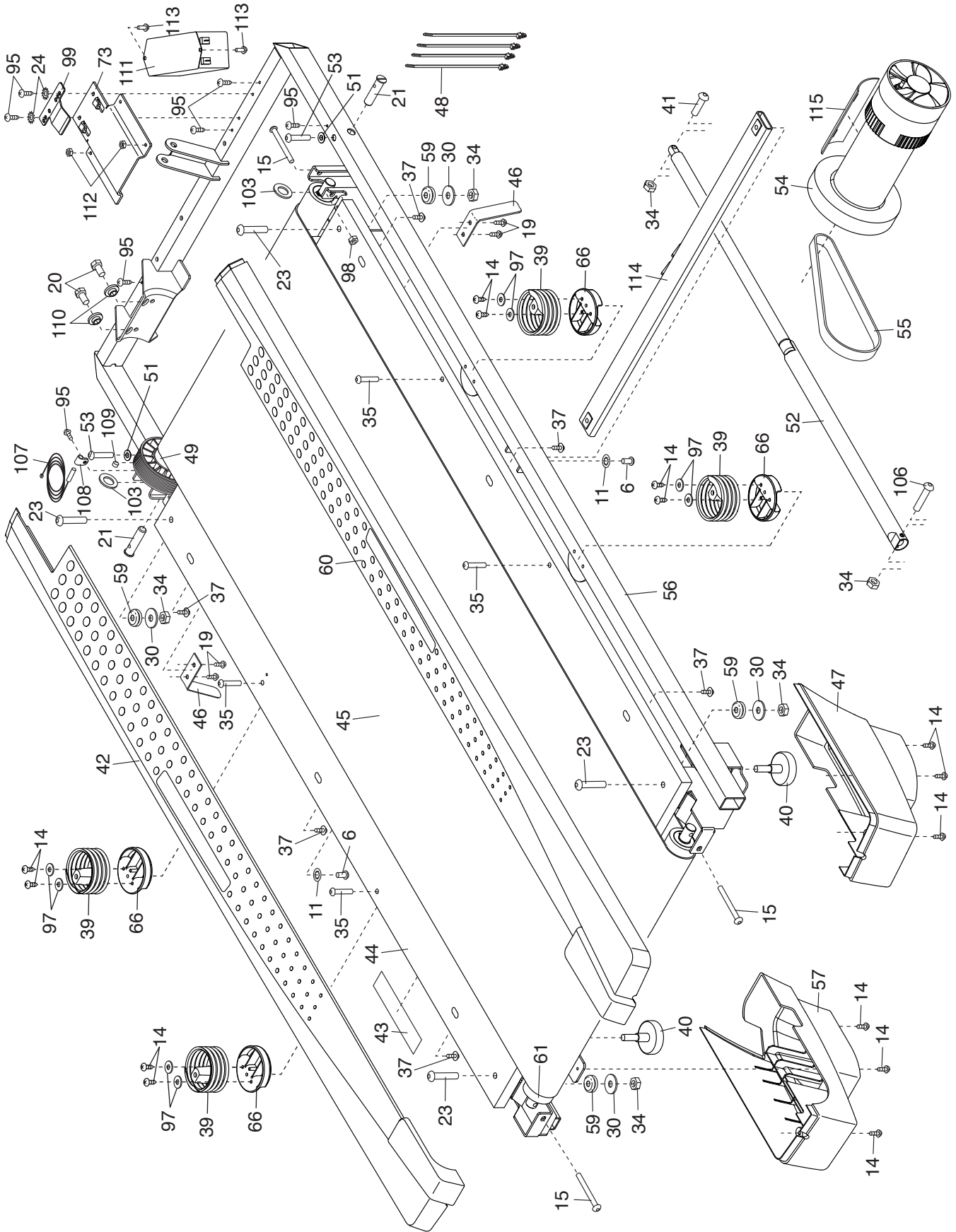

EXPLODED DRAWING B

Model No. PETL79816.2 R0917A

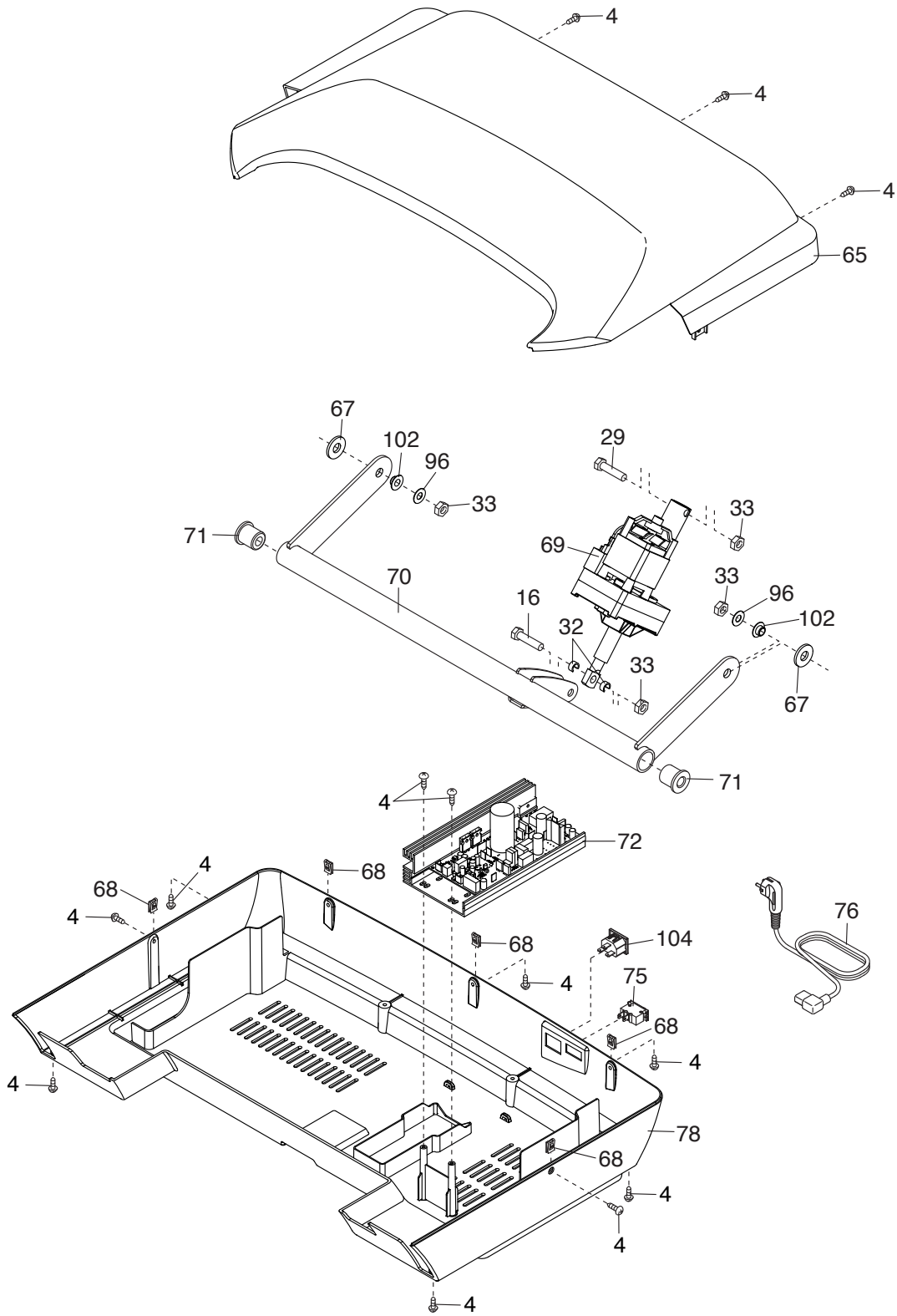

EXPLODED DRAWING D

Model No. PETL79816.2 R0917A

