

EXPLODED DRAWING A

Model No. PETL79817.0 R1216A

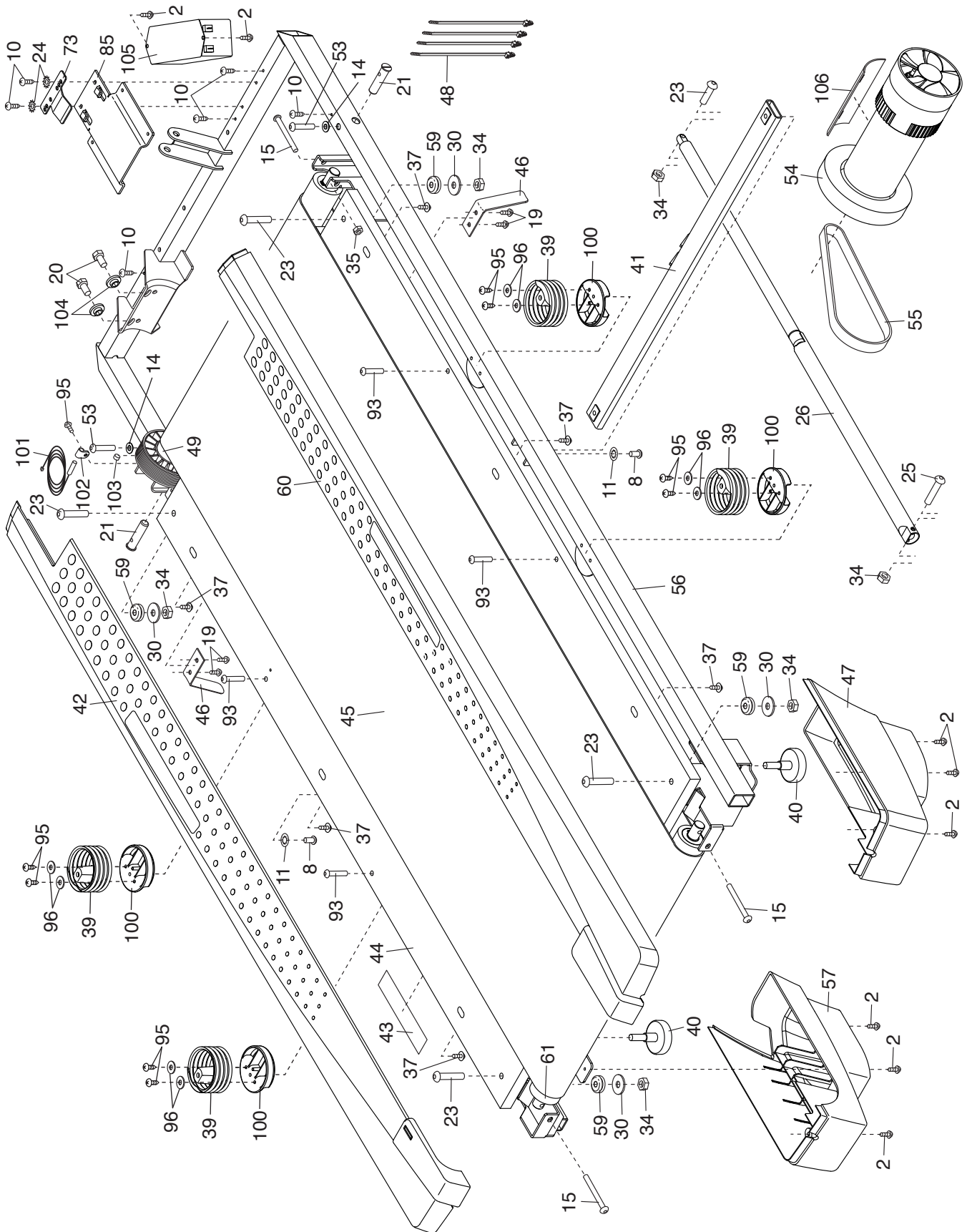

EXPLODED DRAWING B

Model No. PETL79817.0 R1216A

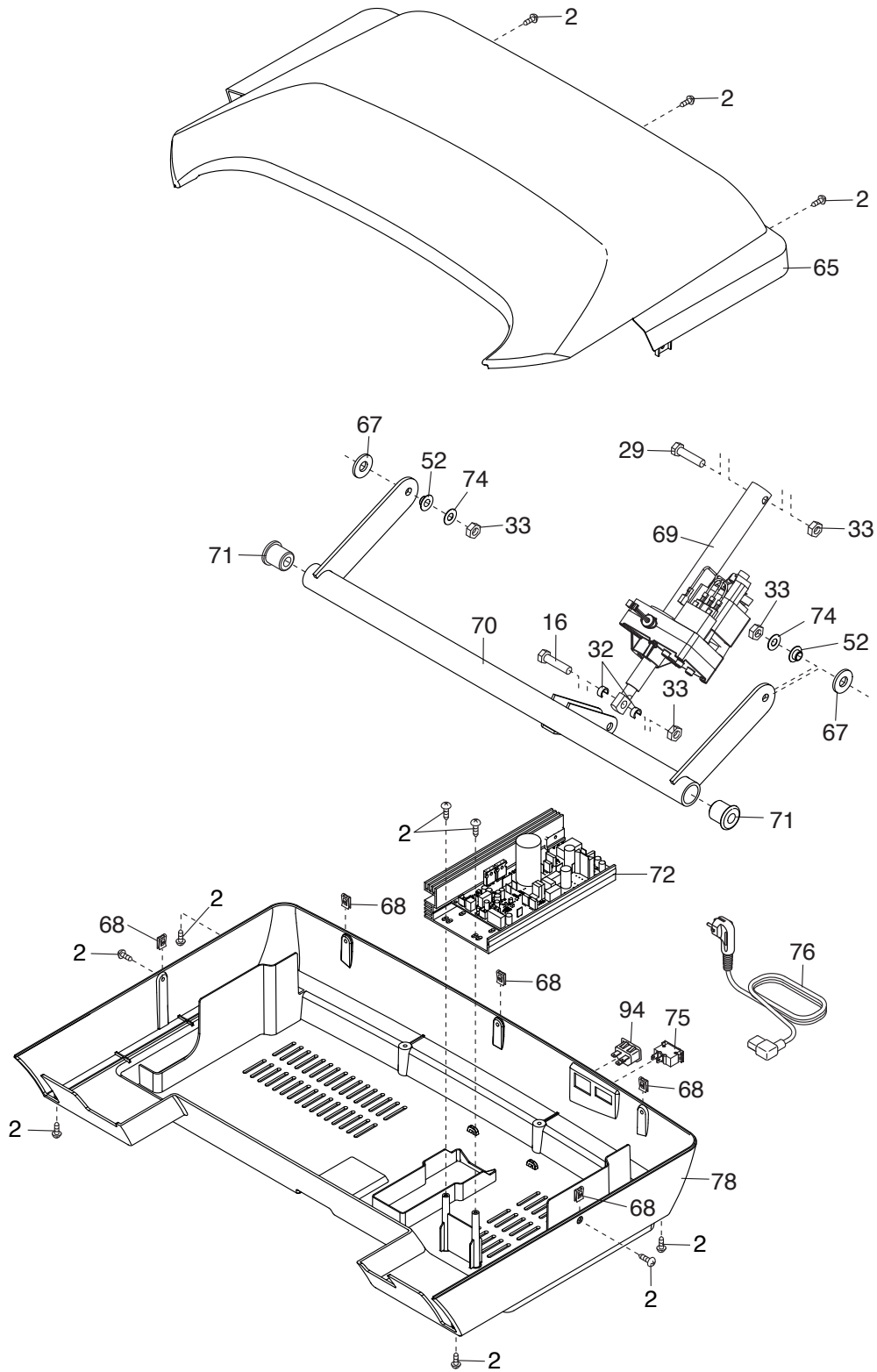

EXPLODED DRAWING C

Model No. PETL79817.0 R1216A

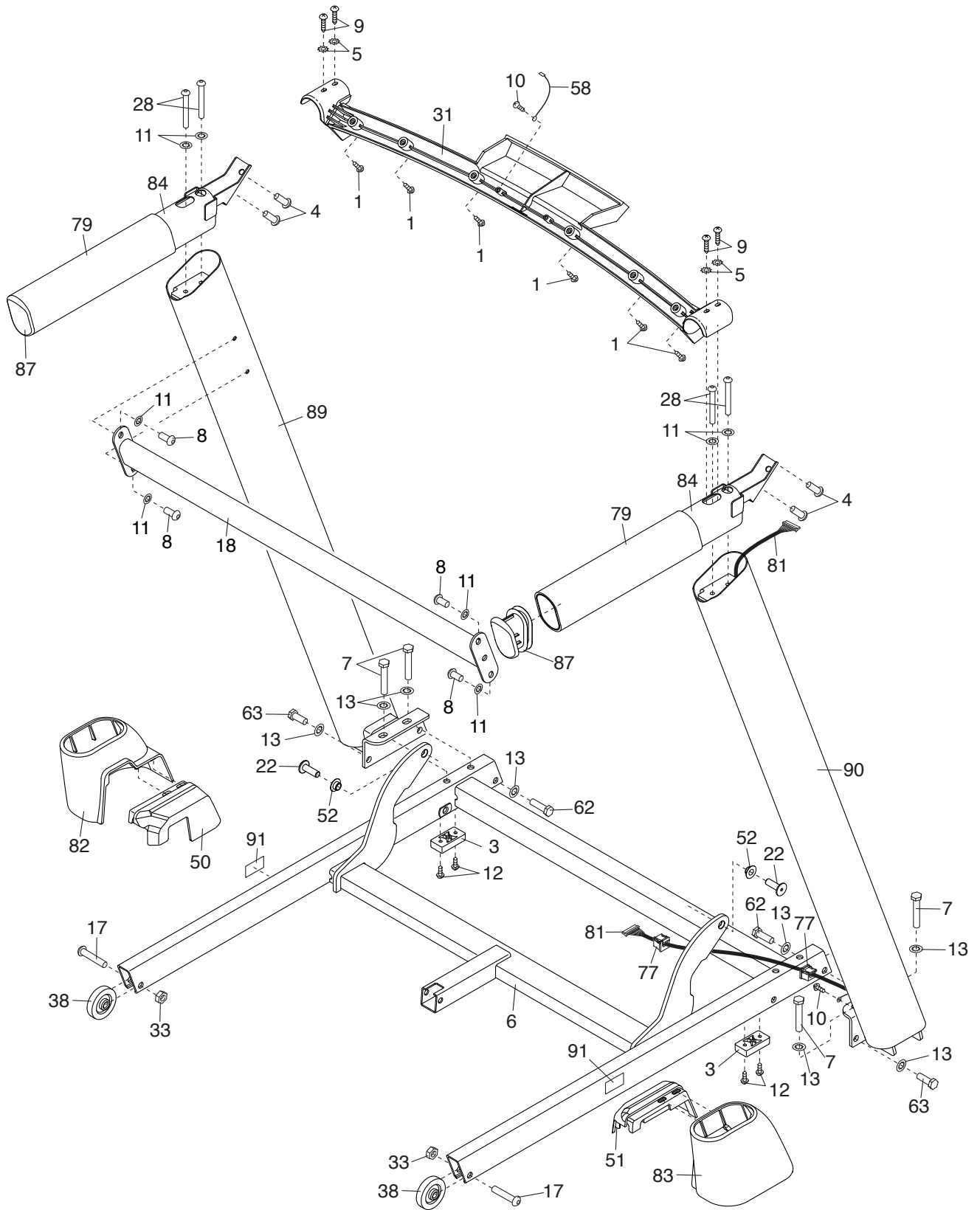

EXPLODED DRAWING D

Model No. PETL79817.0 R1216A

