

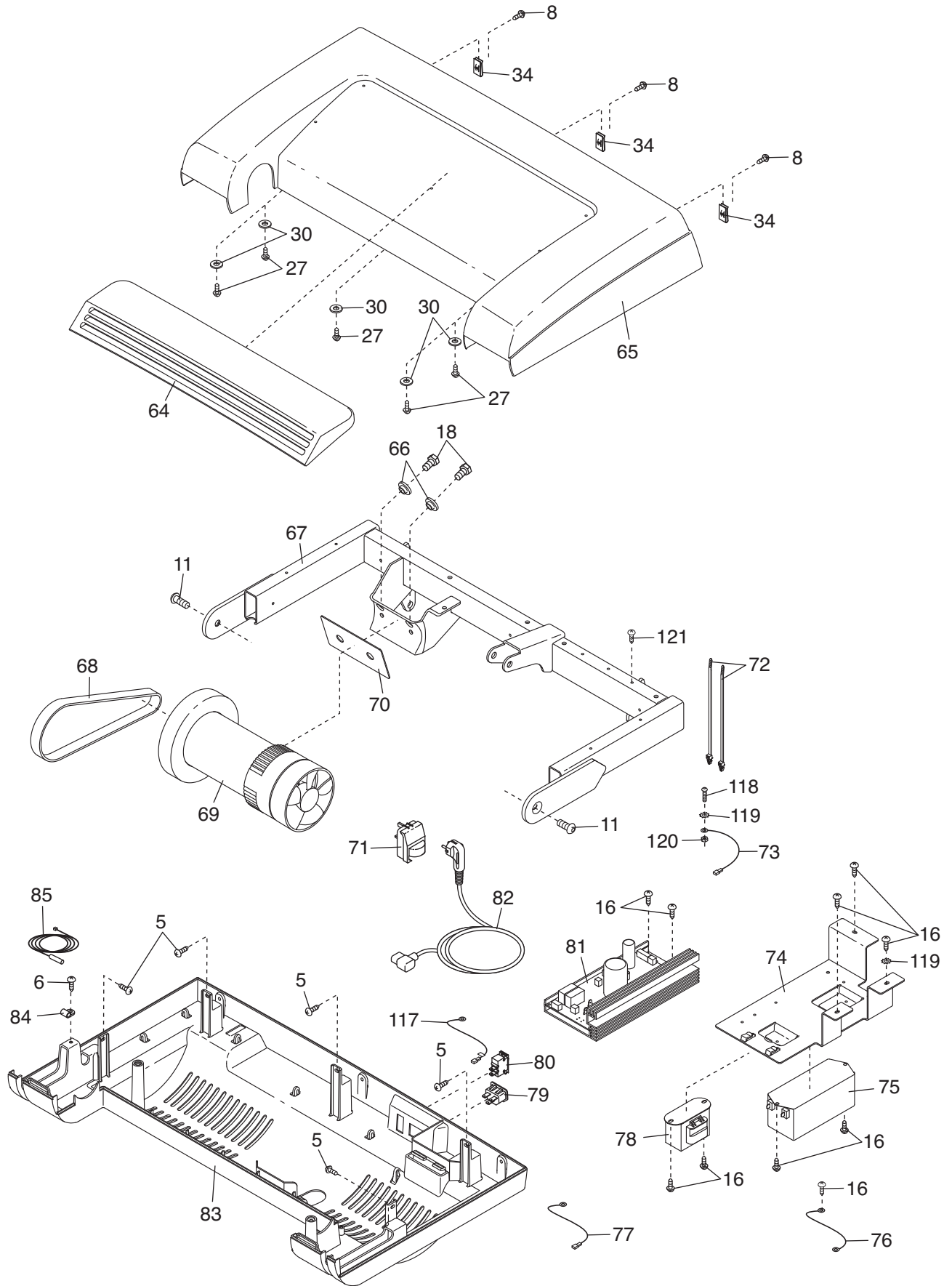

# EXPLODED DRAWING B—Model No. PETL80708.0

R1208A



# EXPLODED DRAWING C—Model No. PETL80708.0

R1208A

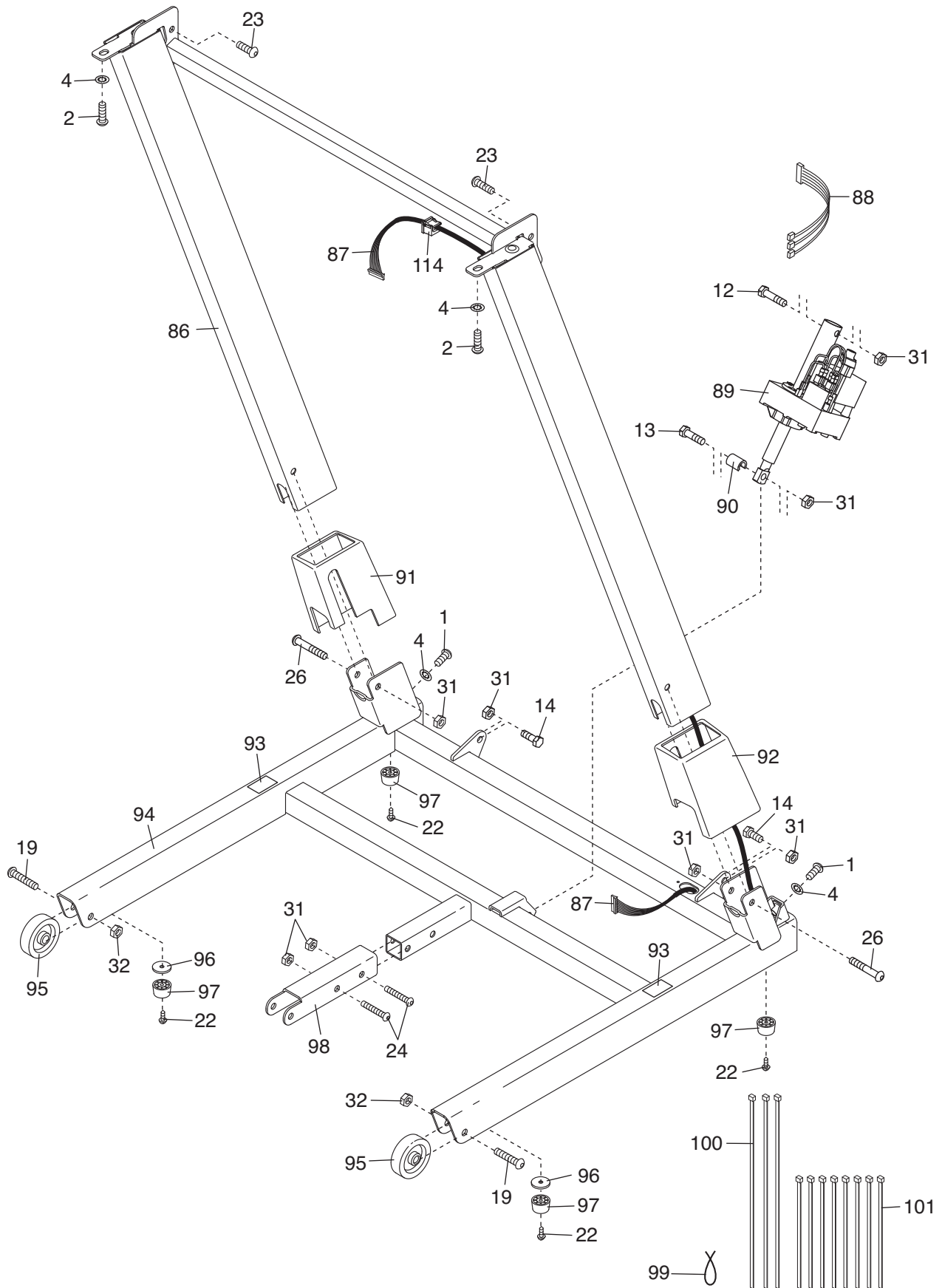

# EXPLODED DRAWING D—Model No. PETL80708.0

R1208A

