

# EXPLODED DRAWING A

Model No. PETL80711.0 R0412A

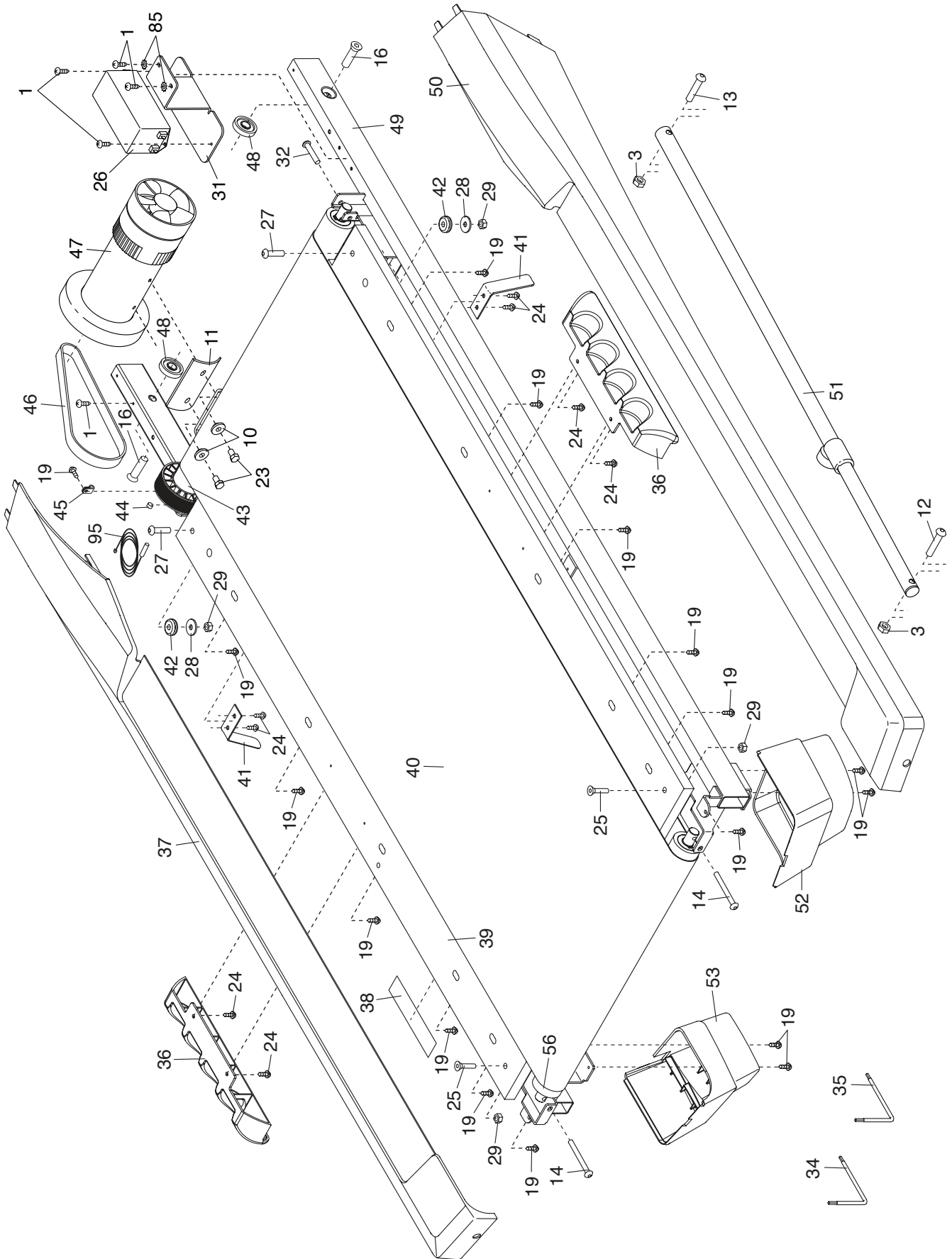

# EXPLODED DRAWING B

Model No. PETL80711.0 R0412A

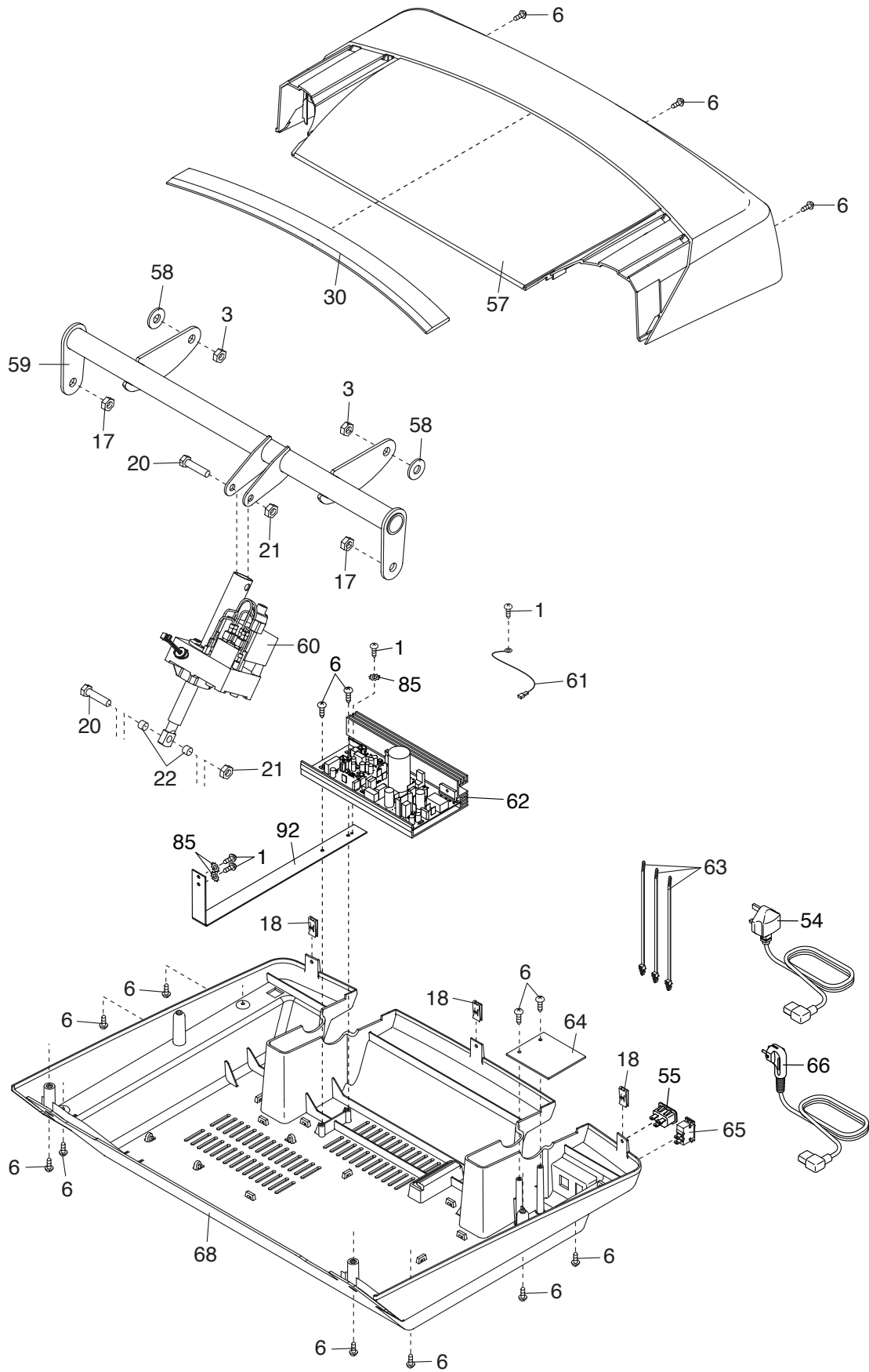

# EXPLODED DRAWING C

Model No. PETL80711.0 R0412A

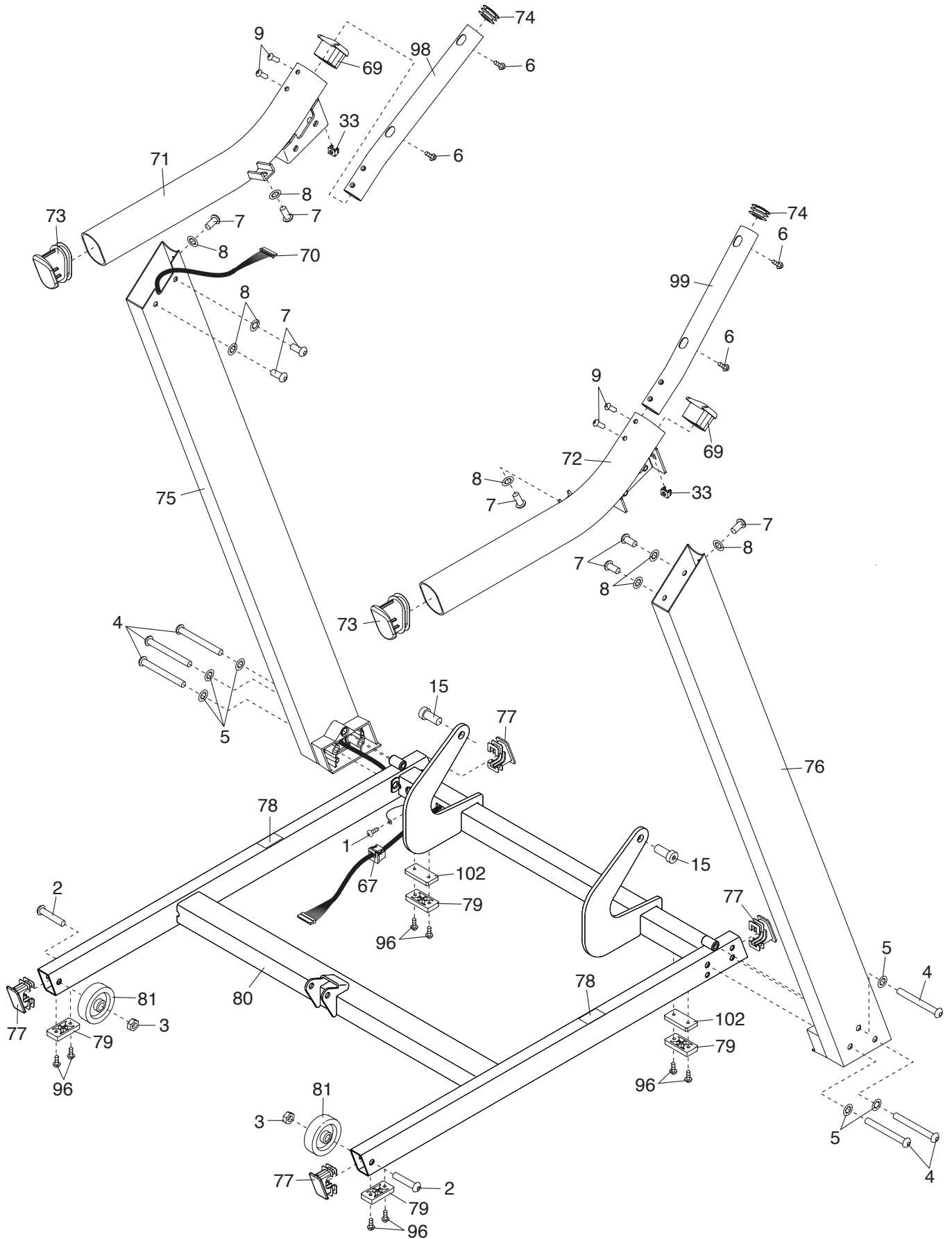

# EXPLODED DRAWING D

Model No. PETL80711.0 R0412A

