

# EXPLODED DRAWING A

Model No. PETL80715.0 R0115A

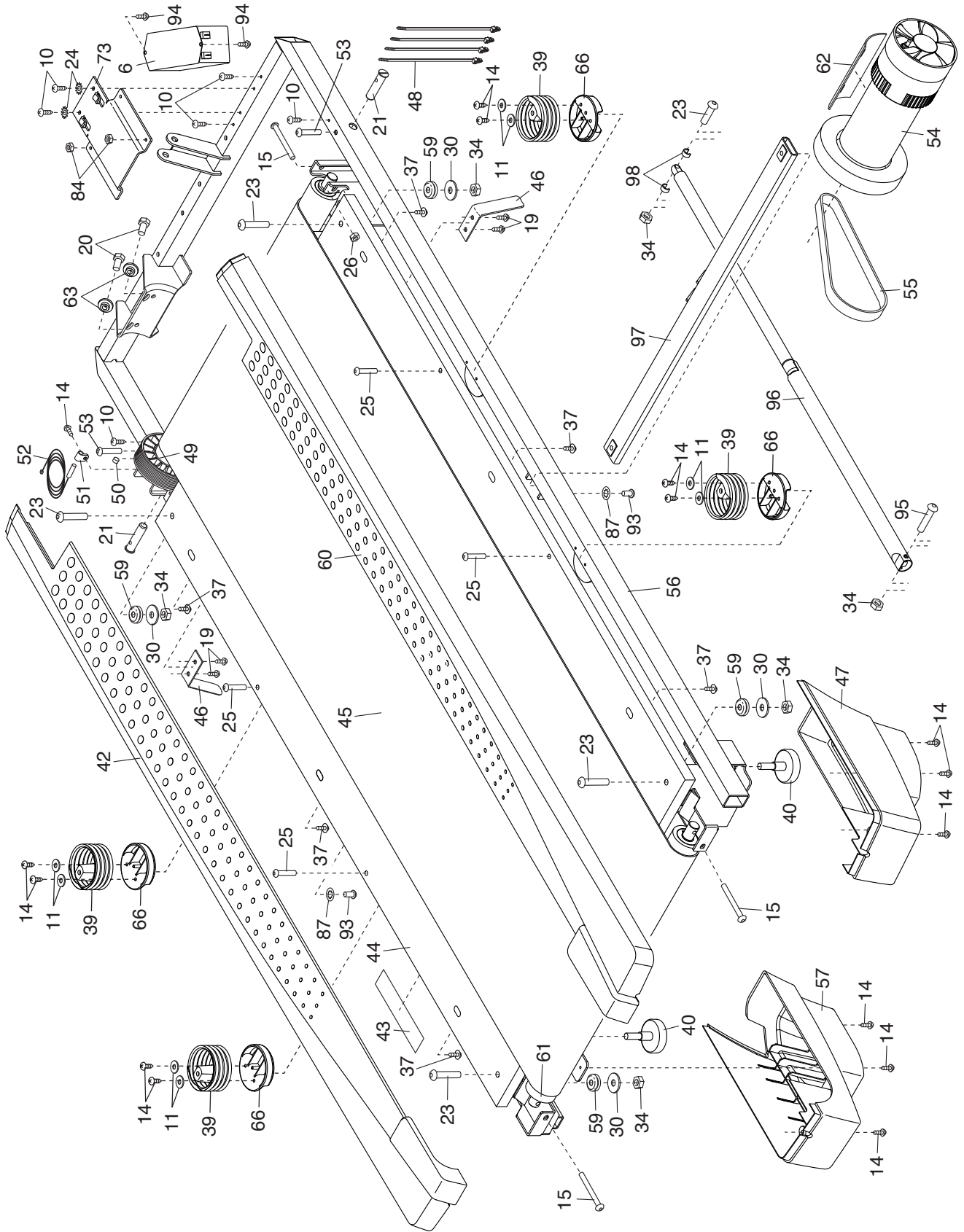

# EXPLODED DRAWING B

Model No. PETL80715.0 R0115A

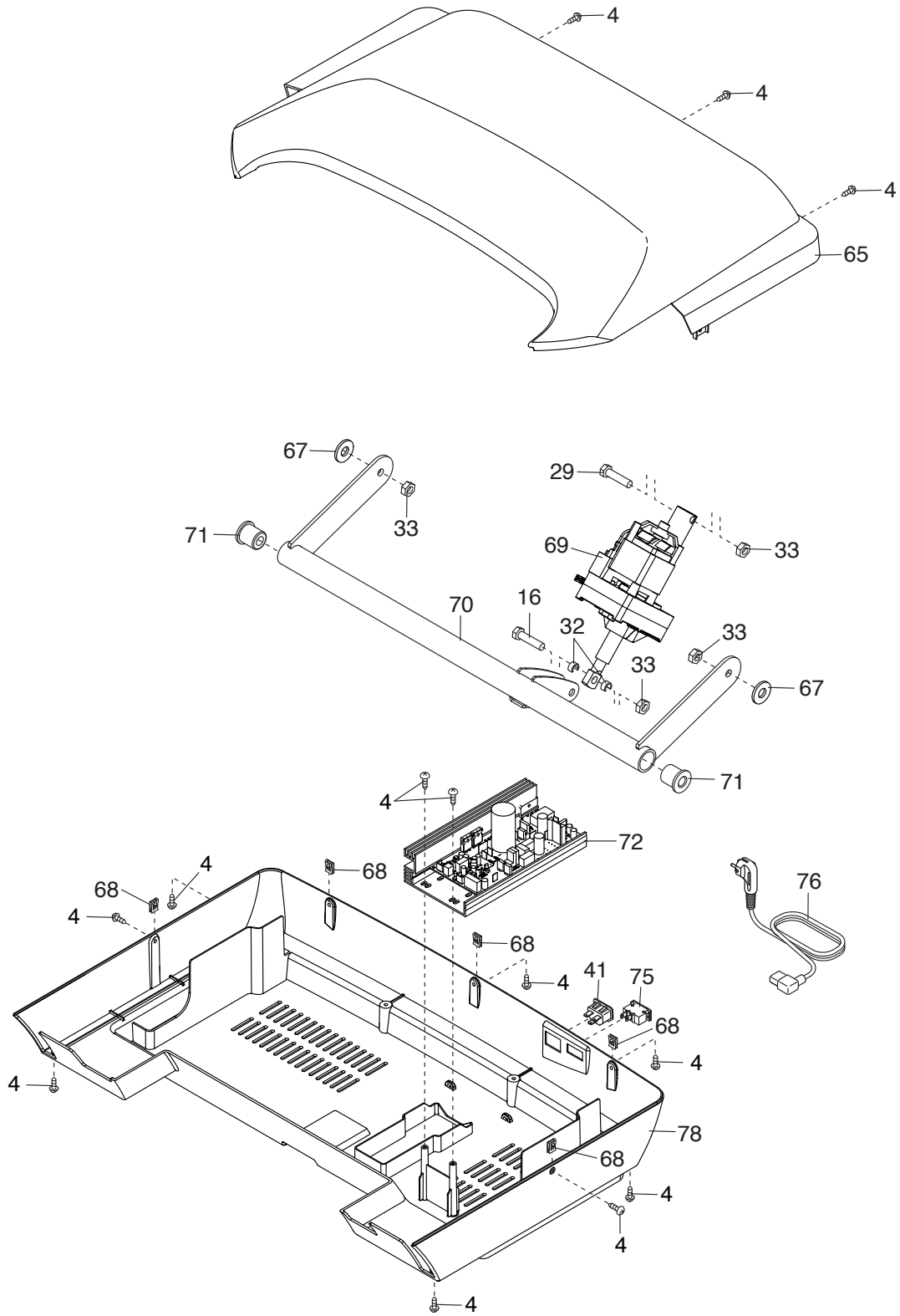

# EXPLODED DRAWING C

Model No. PETL80715.0 R0115A

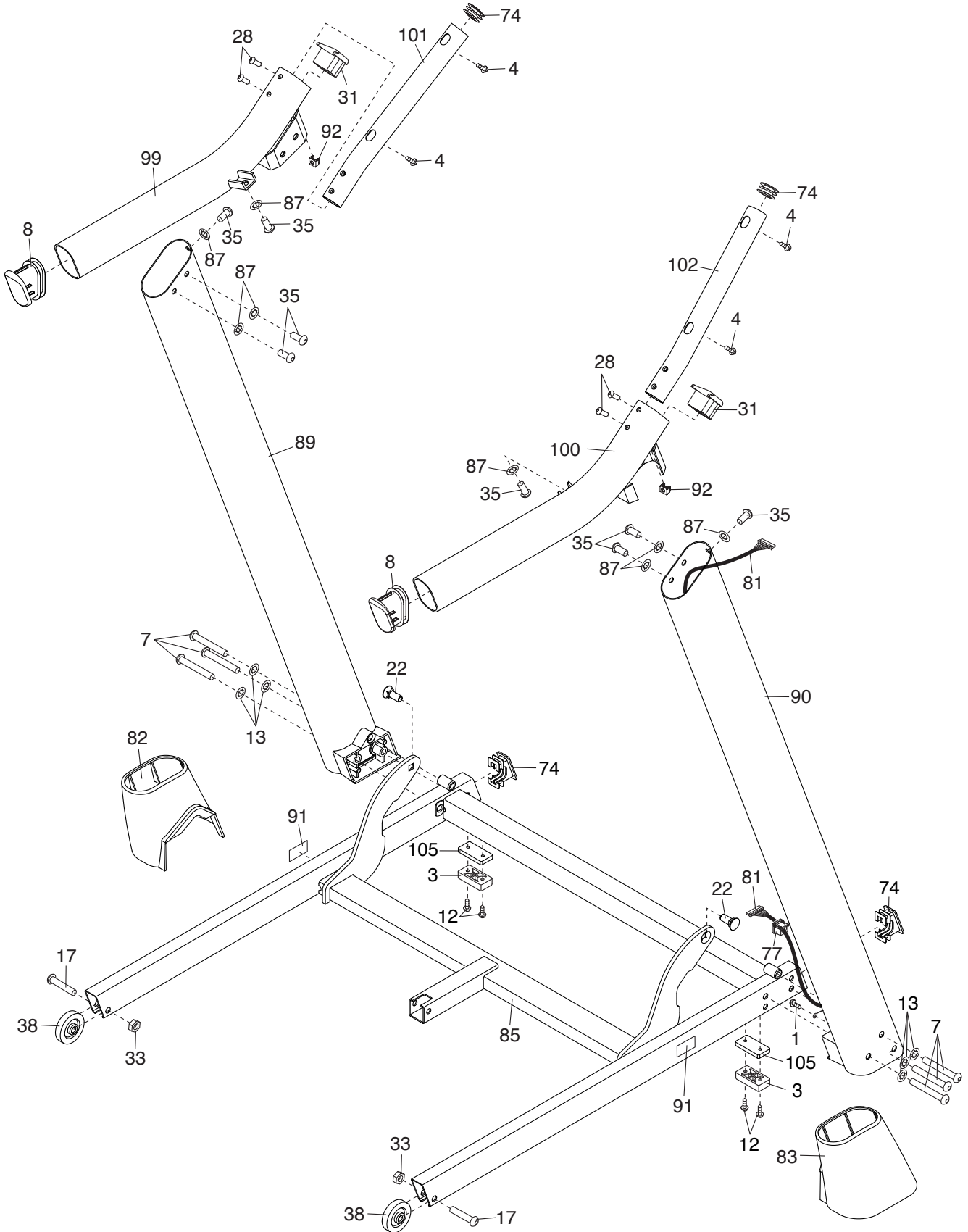

# EXPLODED DRAWING D

Model No. PETL80715.0 R0115A

