

EXPLODED DRAWING A—Model No. PETL80910.0

R0810A

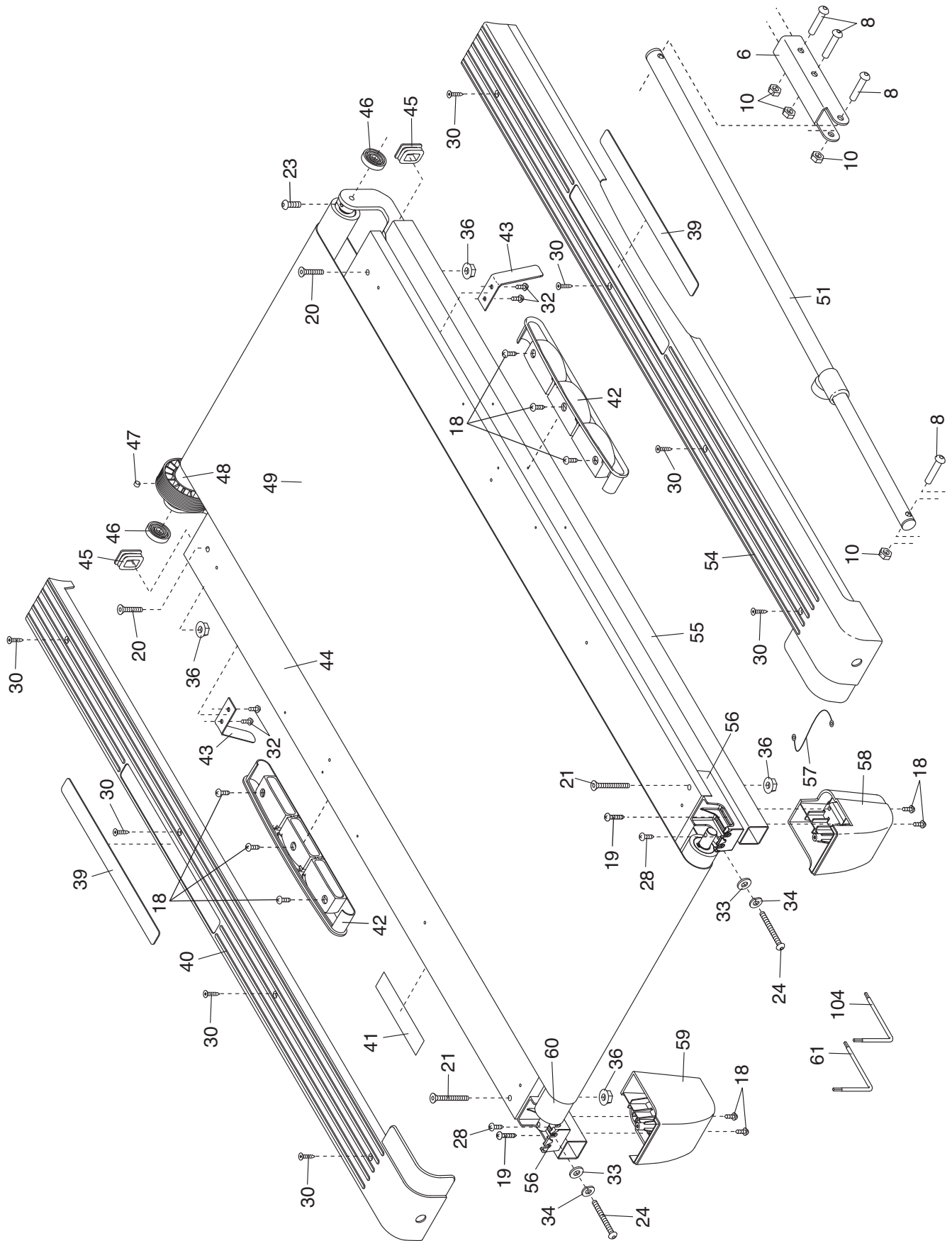

EXPLODED DRAWING B—Model No. PETL80910.0

R0810A

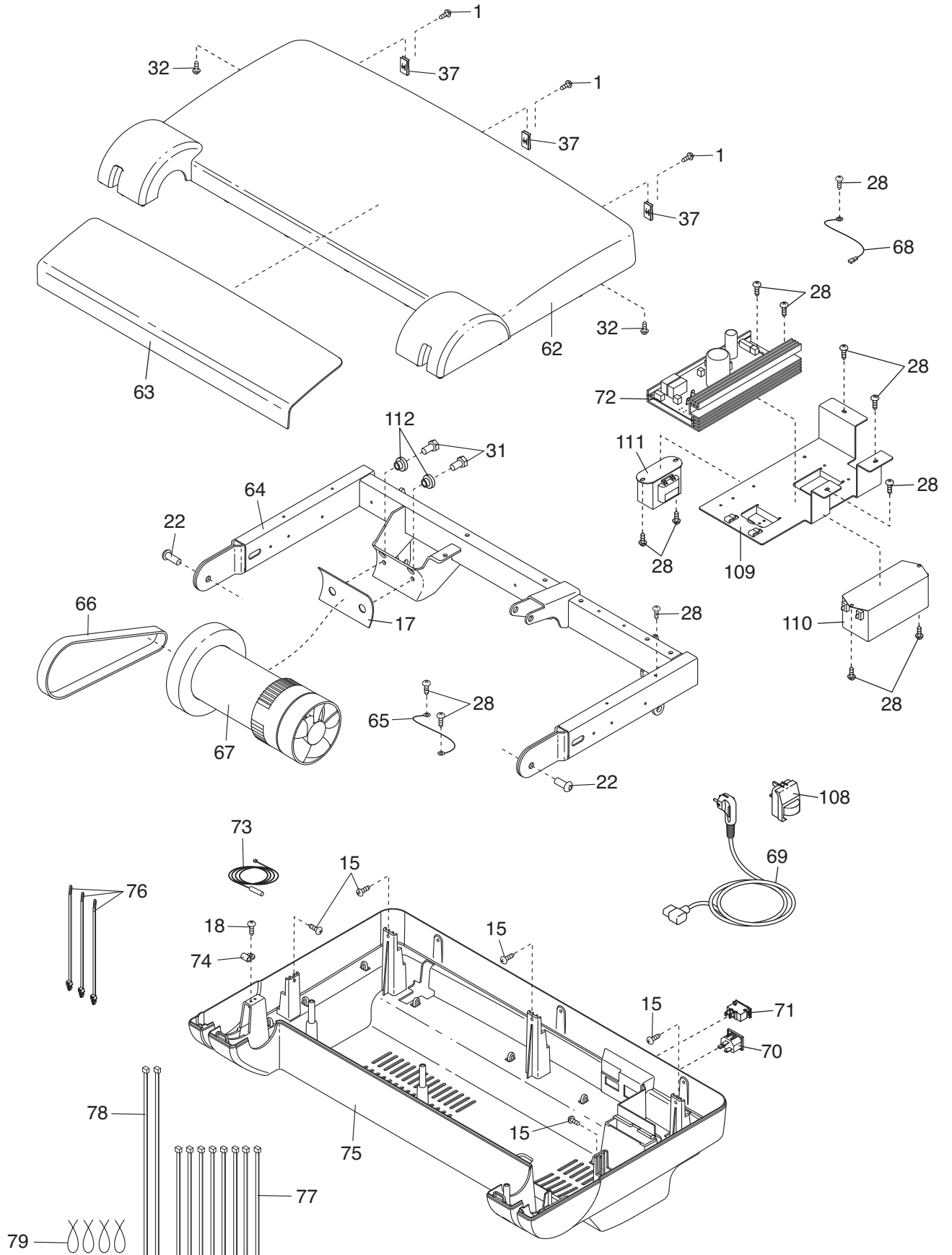

EXPLODED DRAWING C—Model No. PETL80910.0

R0810A

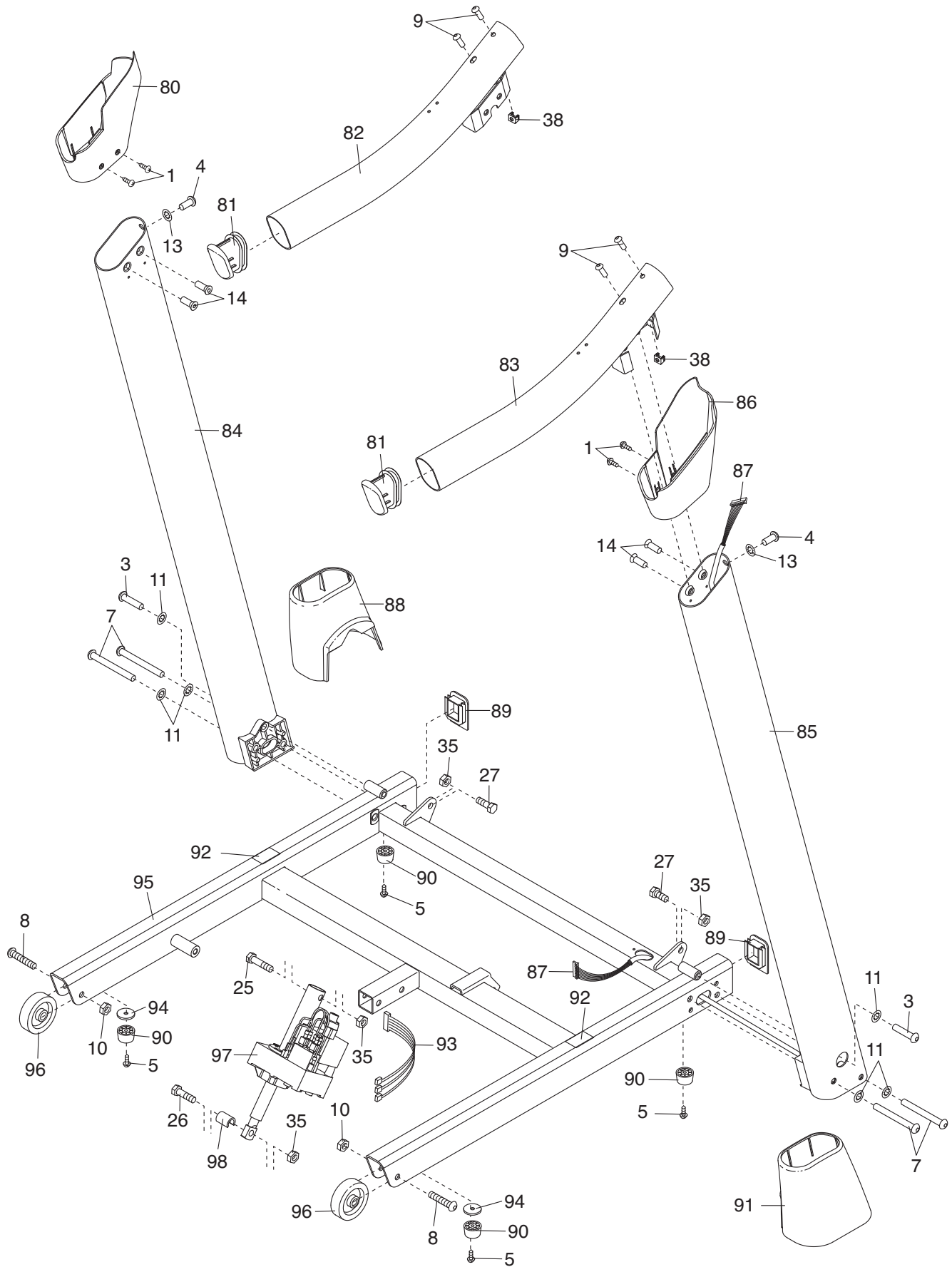

EXPLODED DRAWING D—Model No. PETL80910.0

R0810A

