

EXPLODED DRAWING A

Model No. PETL80911.0 R0912A

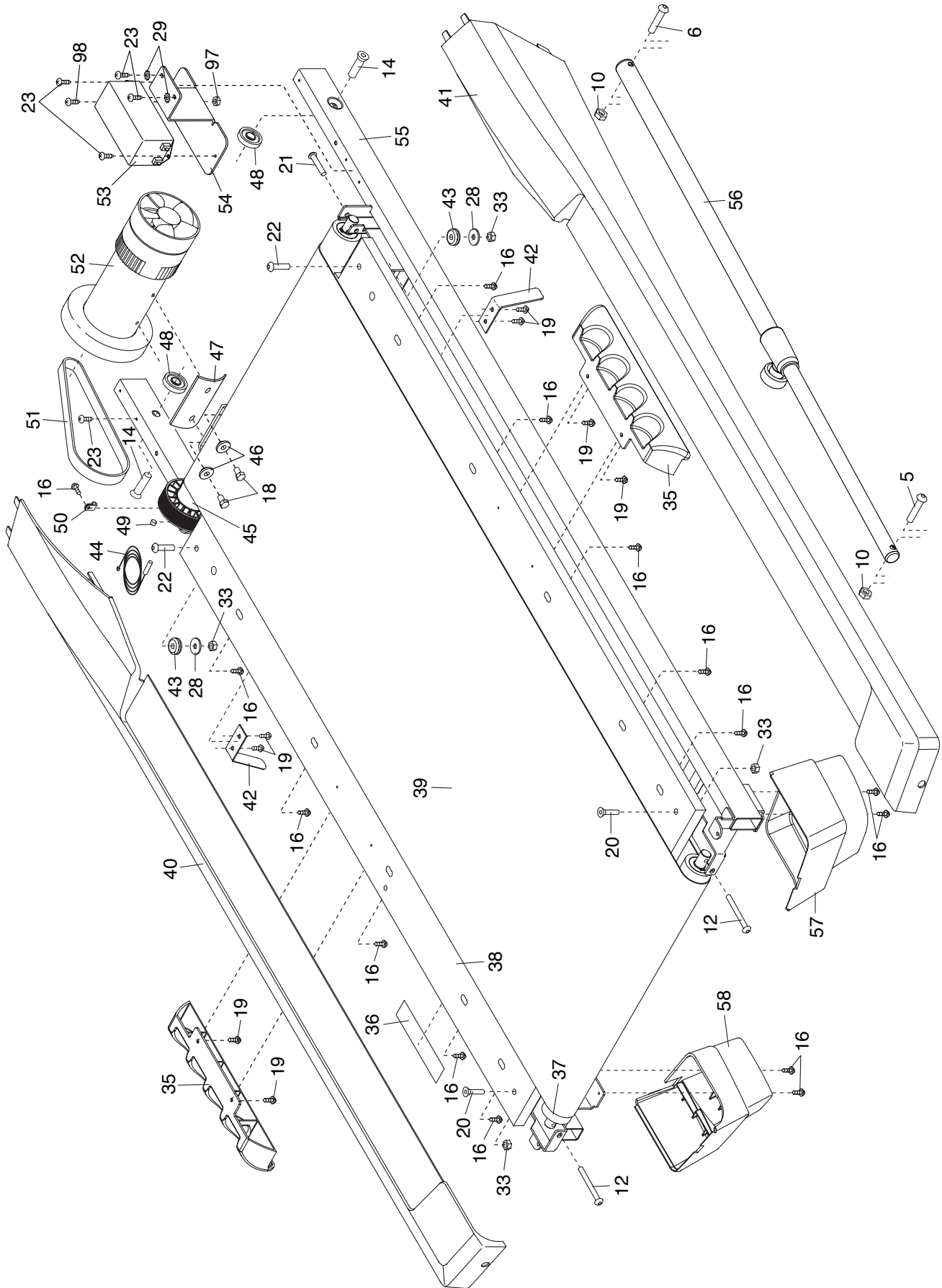

EXPLODED DRAWING B

Model No. PETL80911.0 R0912A

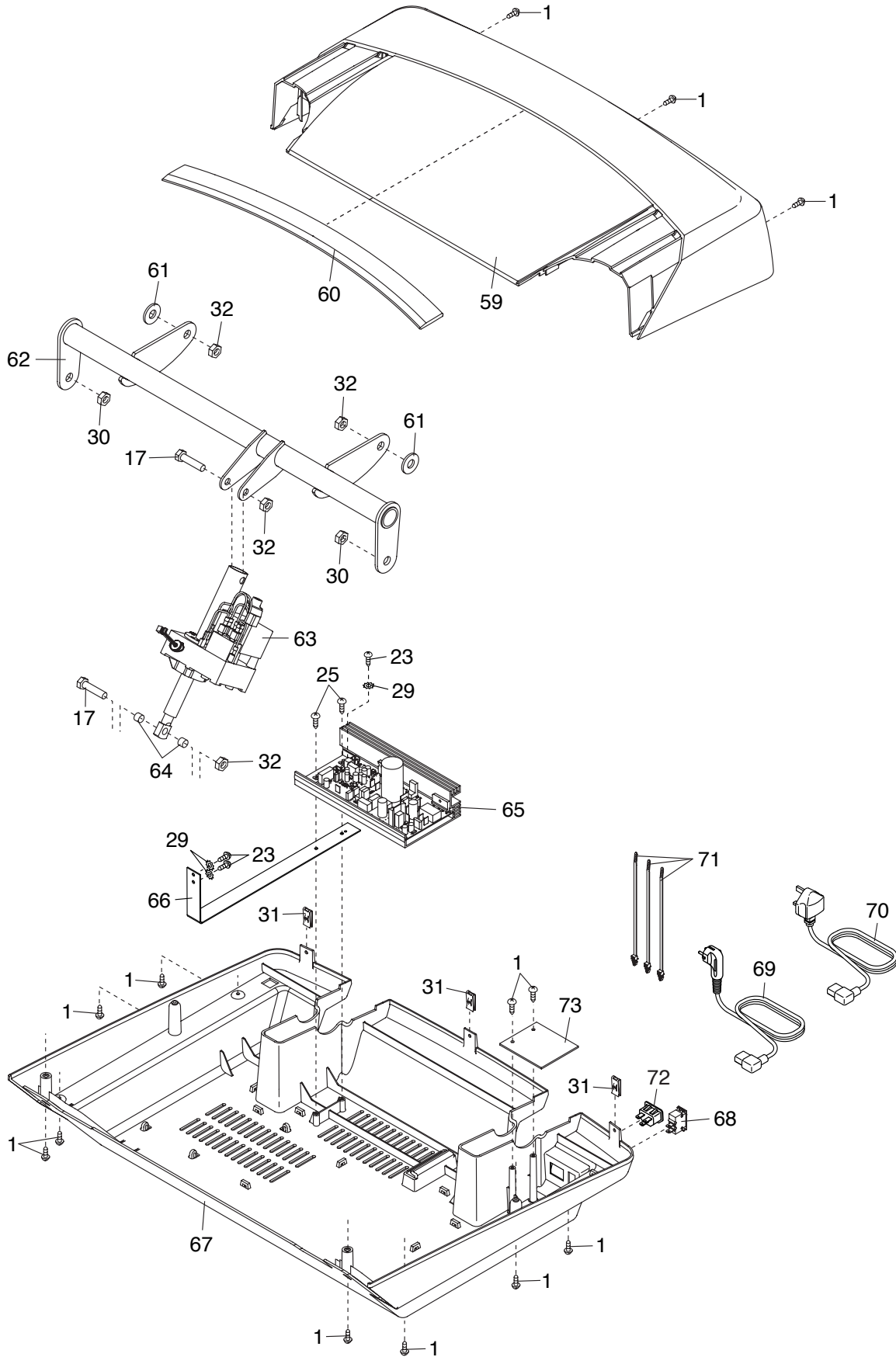

EXPLODED DRAWING C

Model No. PETL80911.0 R0912A

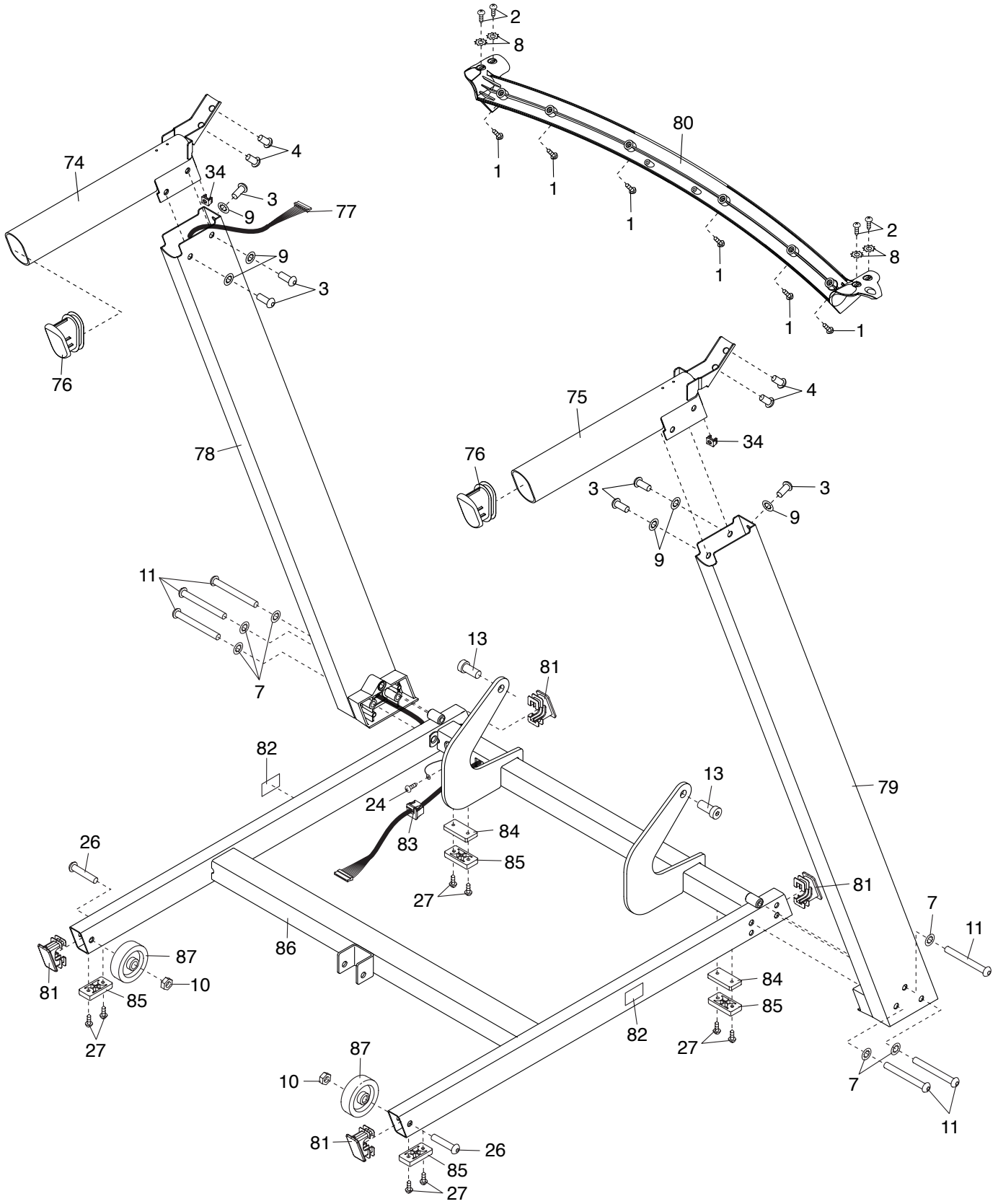

EXPLODED DRAWING D

Model No. PETL80911.0 R0912A

