

EXPLODED DRAWING B

Model No. PETL80911.2 R0513A

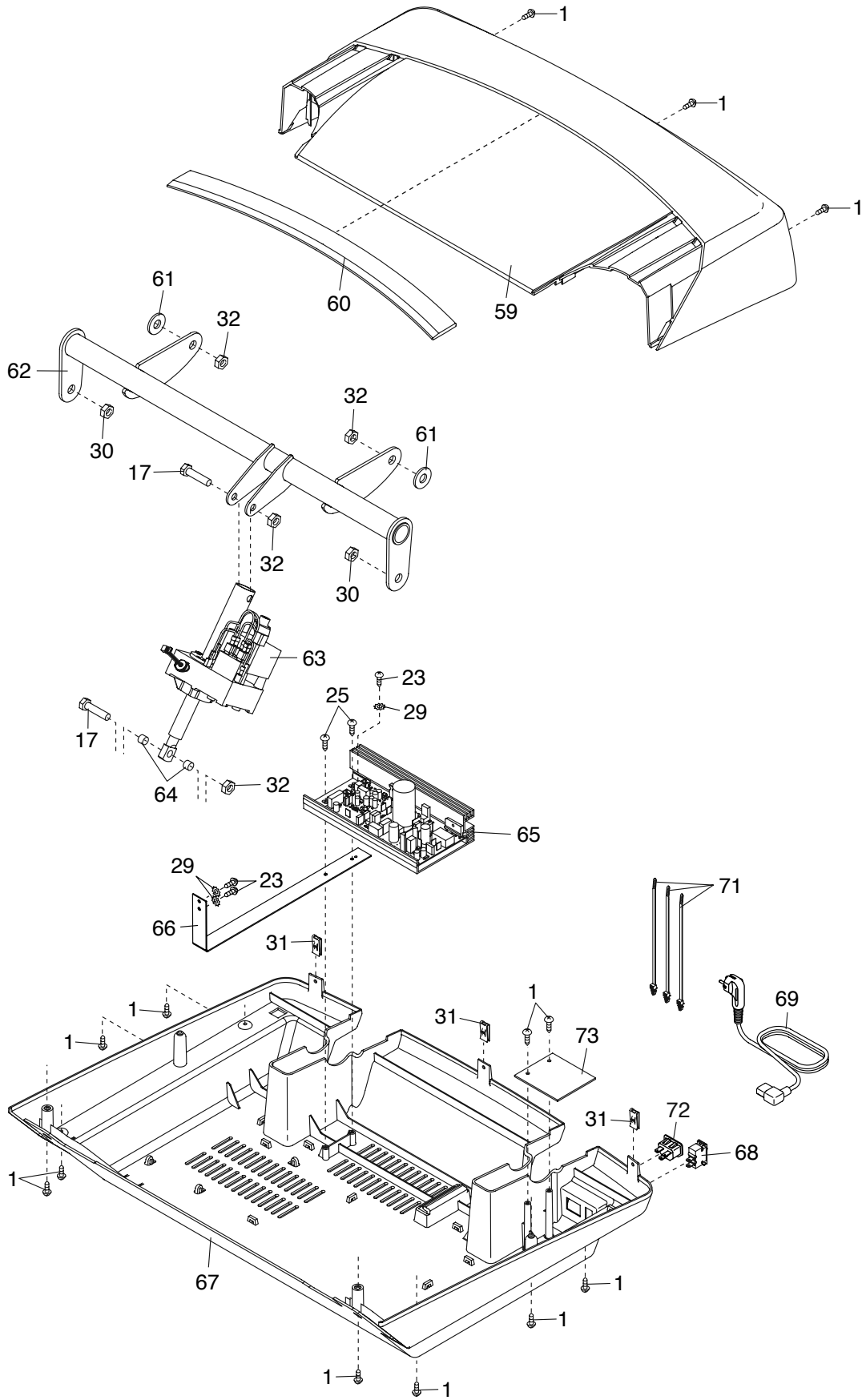

EXPLODED DRAWING C

Model No. PETL80911.2 R0513A

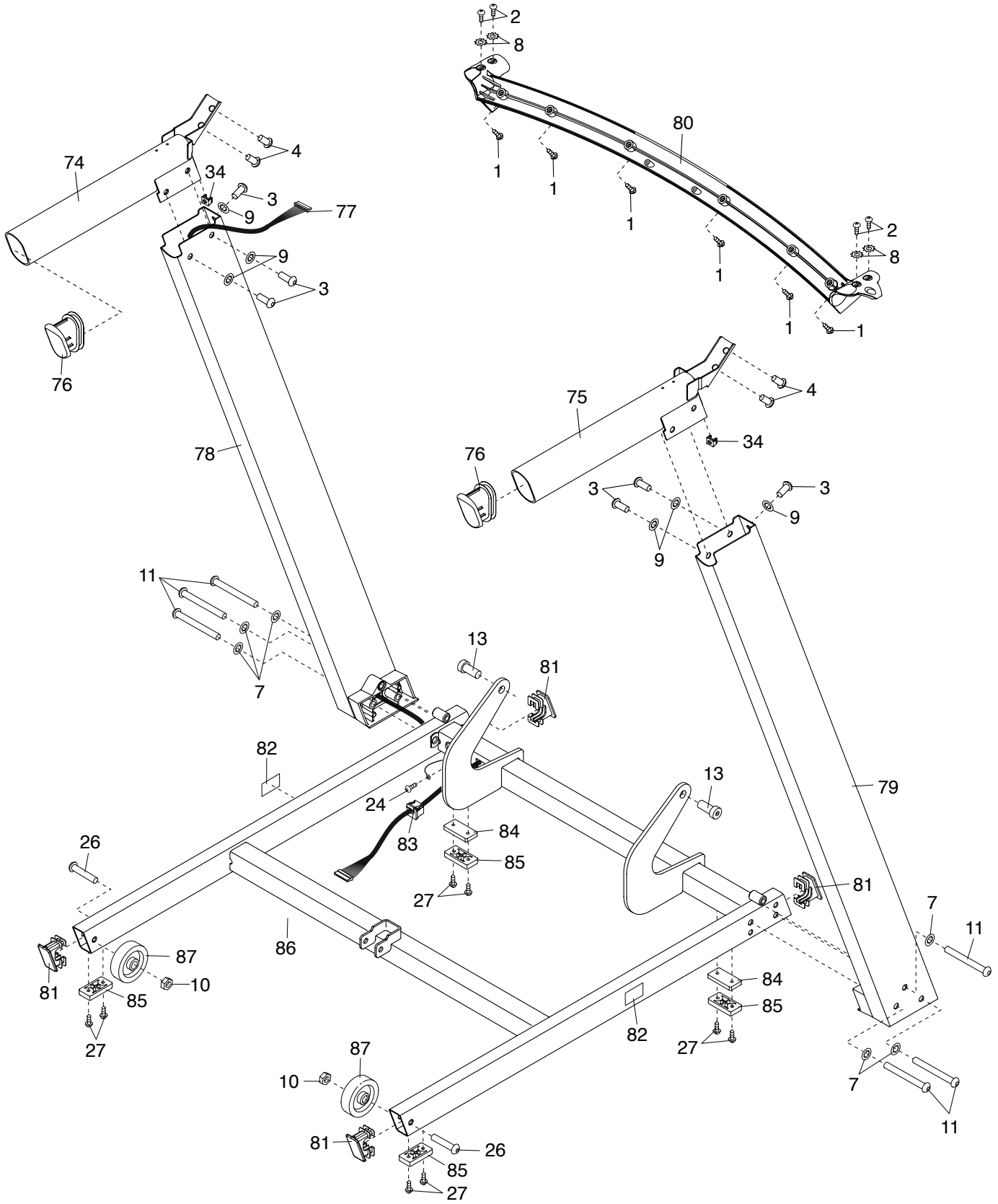

EXPLODED DRAWING D

Model No. PETL80911.2 R0513A

