

# EXPLODED DRAWING A—Model No. PETL81708.2

R0809A

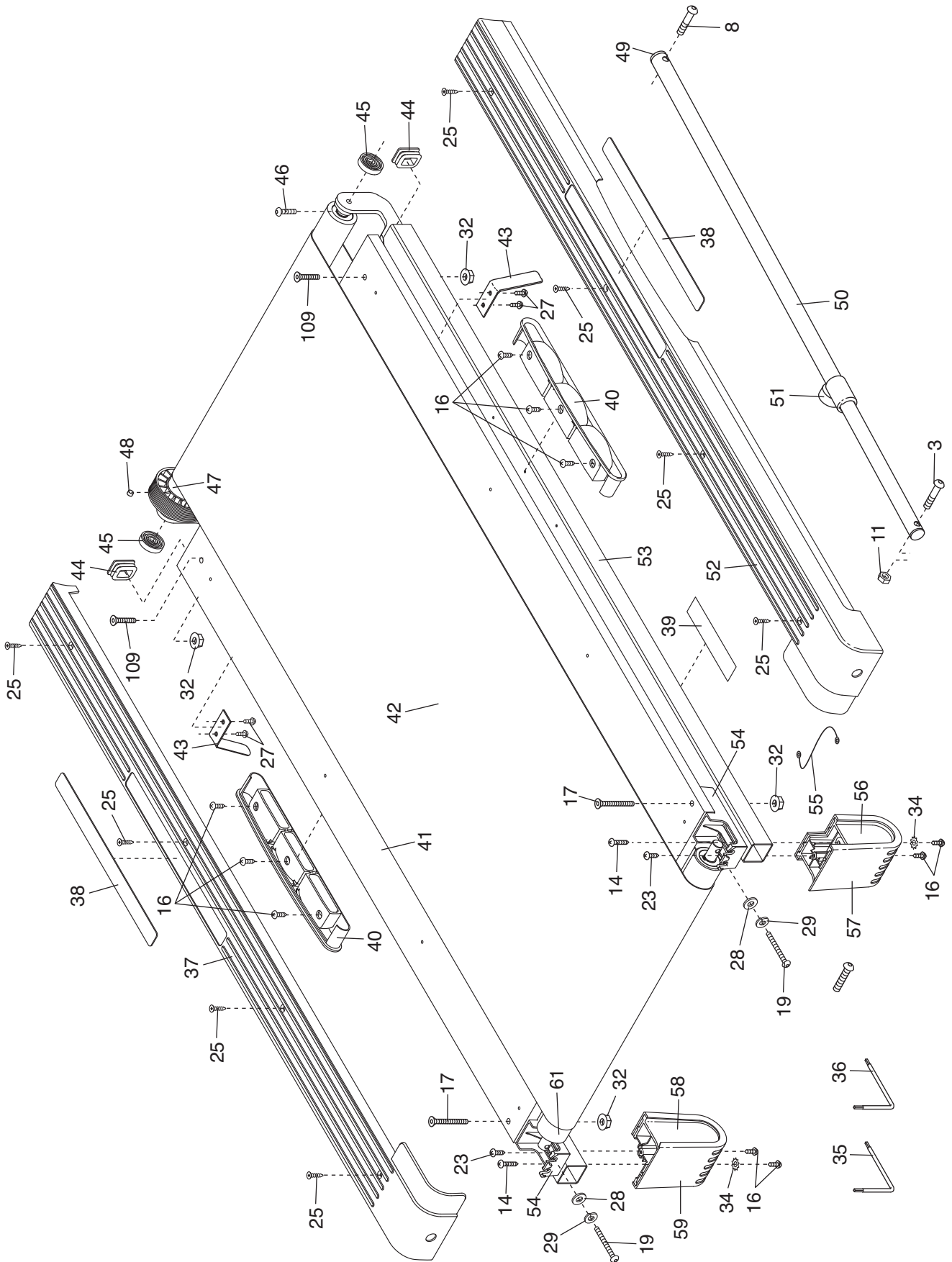

# EXPLODED DRAWING B—Model No. PETL81708.2

R0809A

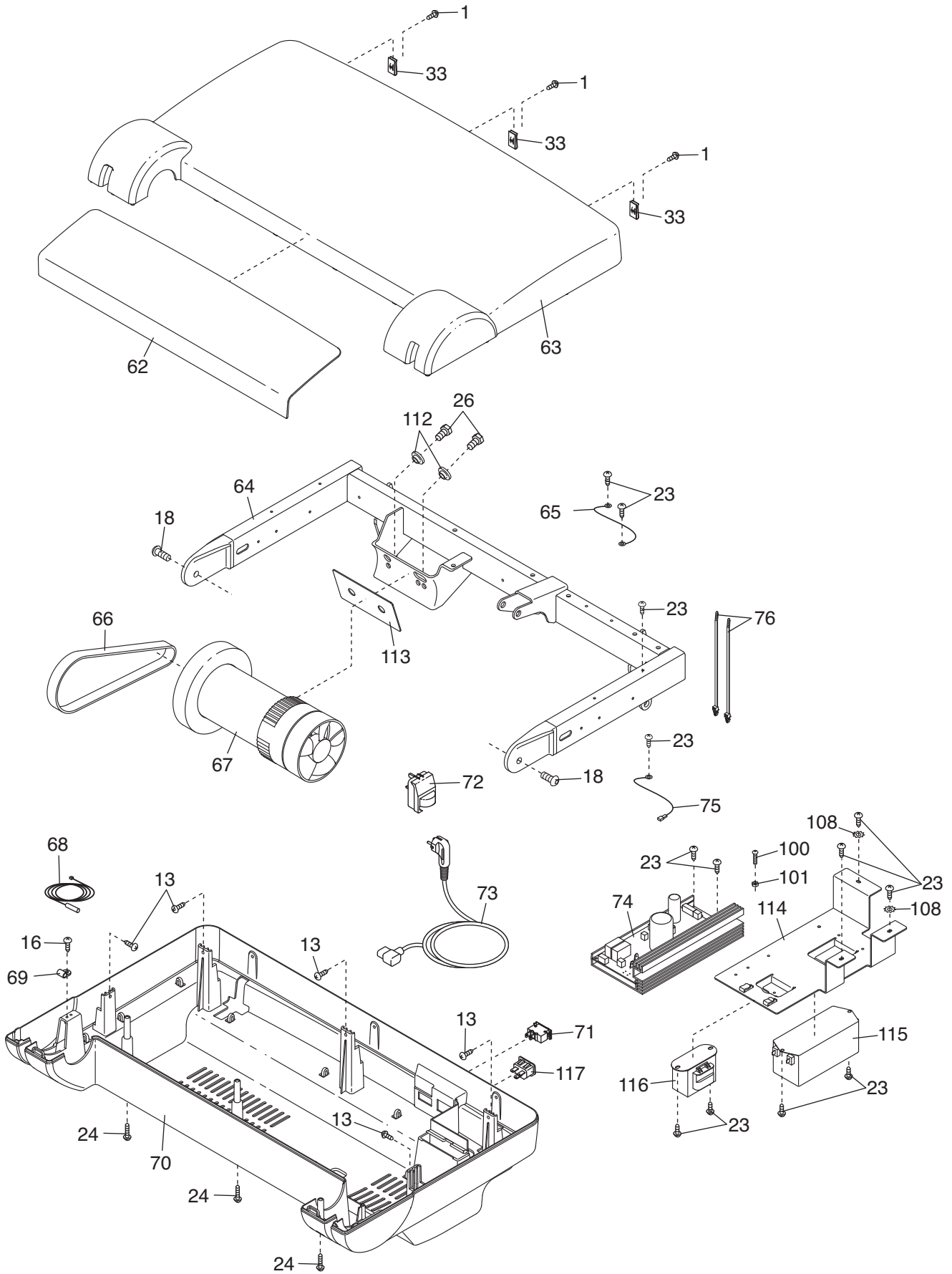

# EXPLODED DRAWING C—Model No. PETL81708.2

R0809A

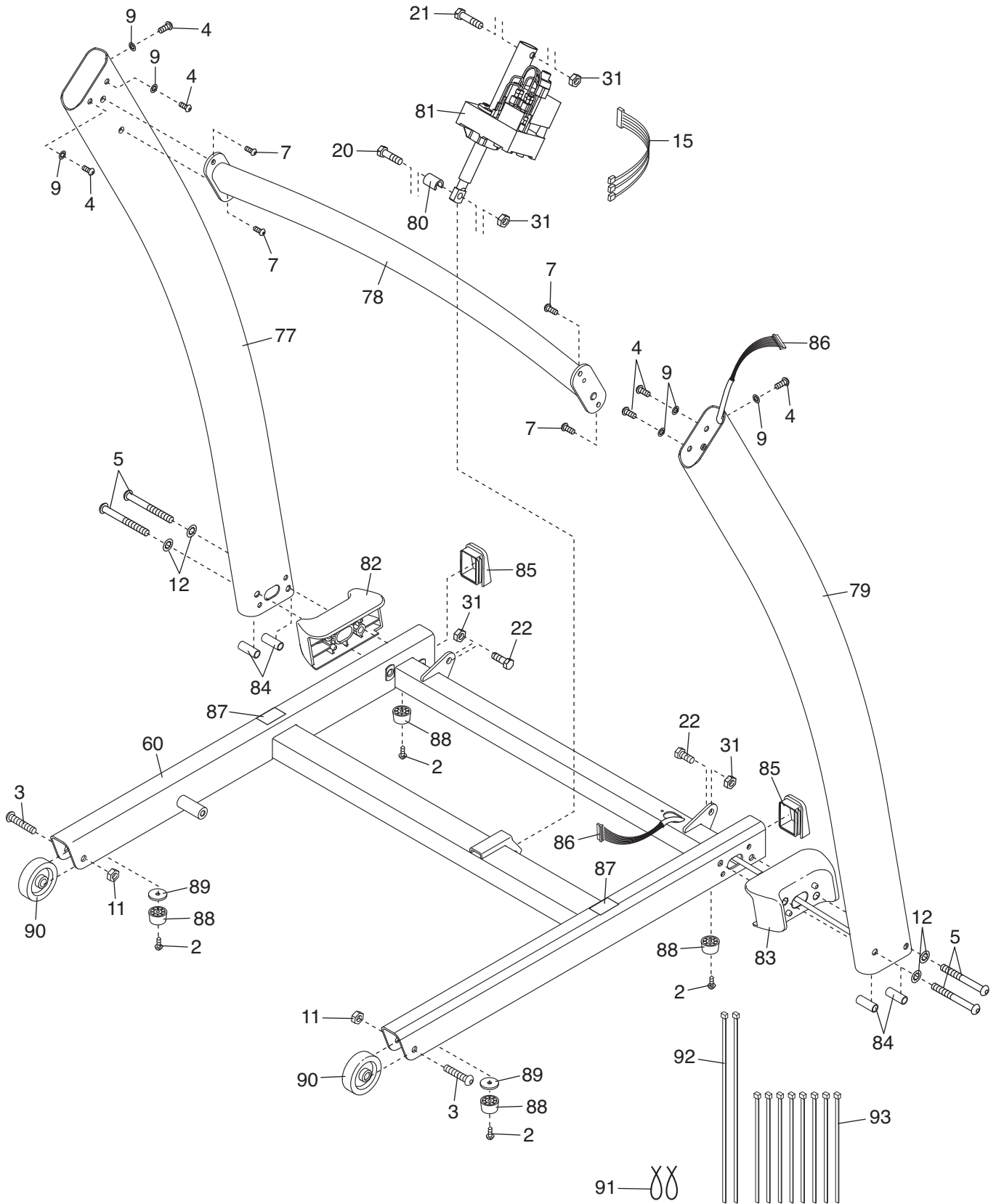

# EXPLODED DRAWING D—Model No. PETL81708.2

R0809A

