

EXPLODED DRAWING A

Model No. PETL81711.0 R1111A

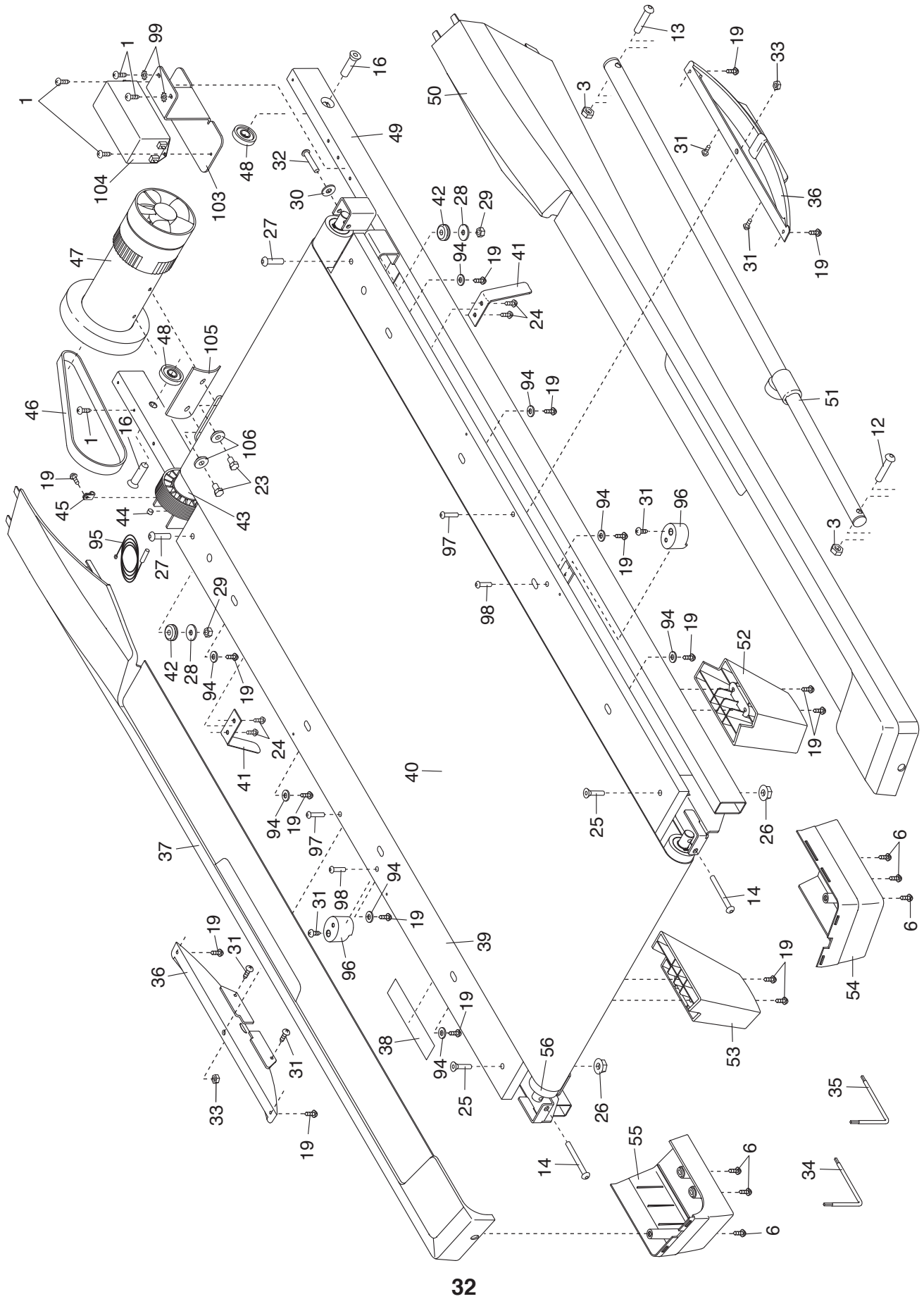

EXPLODED DRAWING B

Model No. PETL81711.0 R1111A

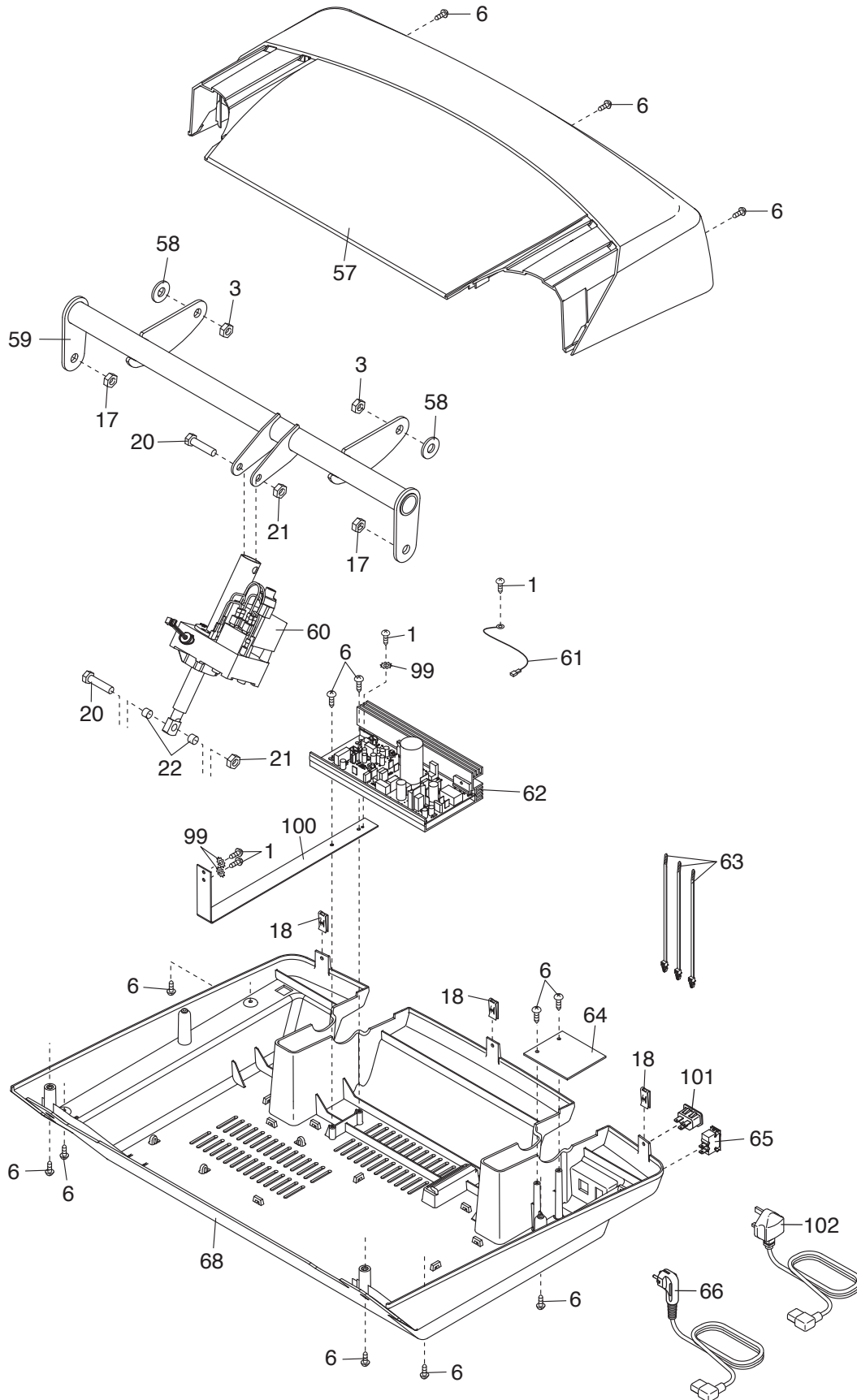

EXPLODED DRAWING C

Model No. PETL81711.0 R1111A

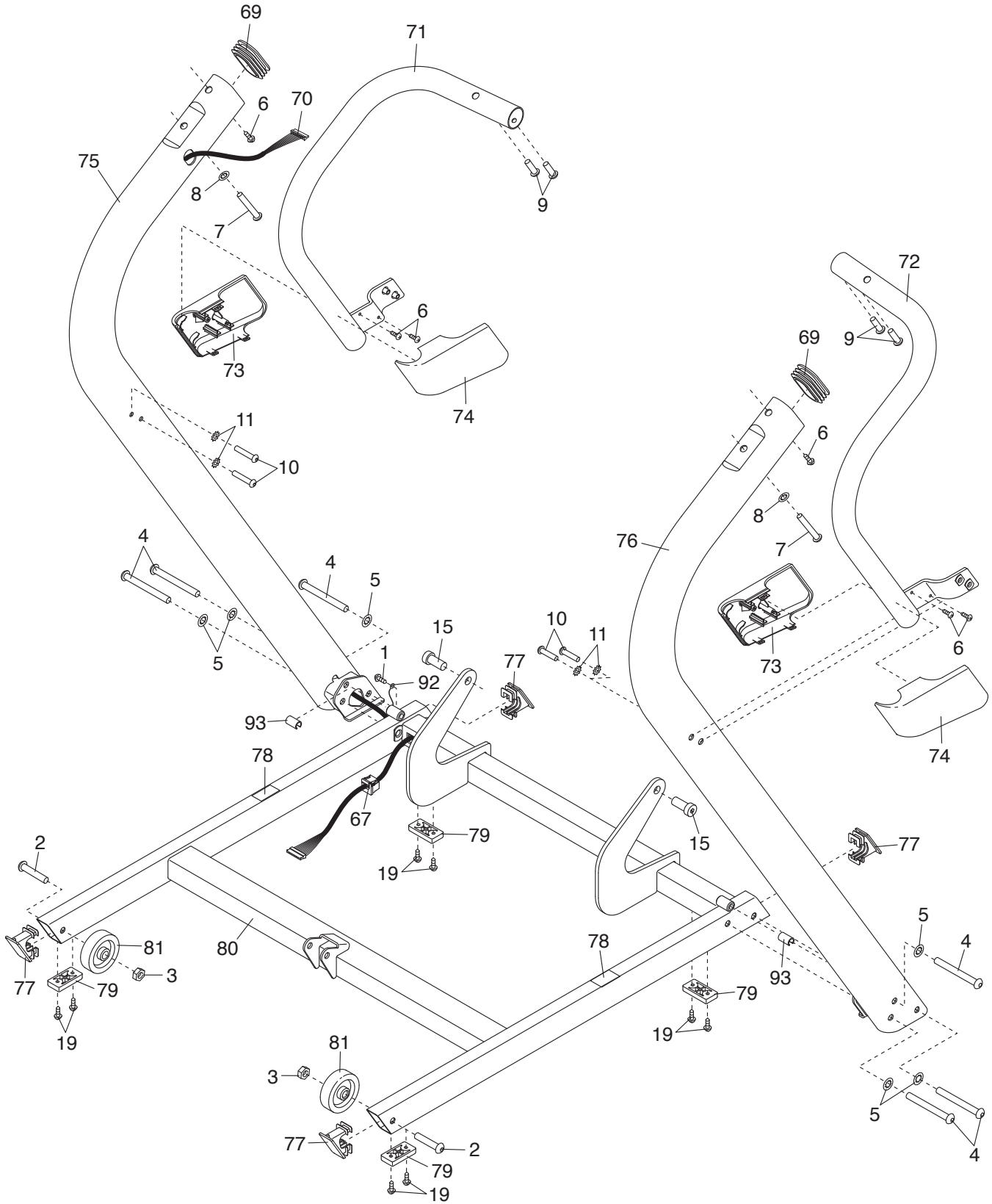

EXPLODED DRAWING D

Model No. PETL81711.0 R1111A

