

# EXPLODED DRAWING A—Model No. PETL91709.0

R0809A

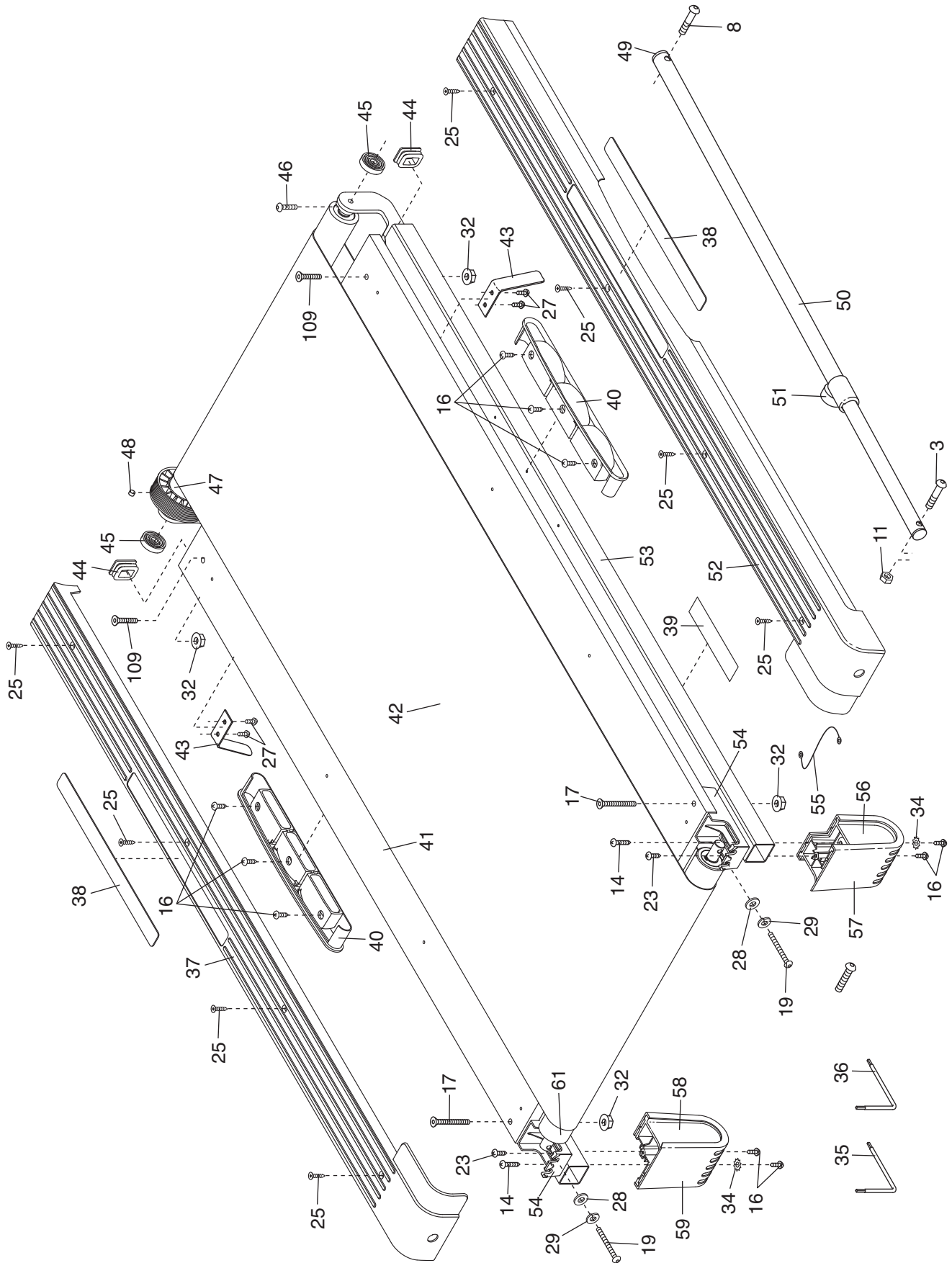

# EXPLODED DRAWING B—Model No. PETL91709.0

R0809A

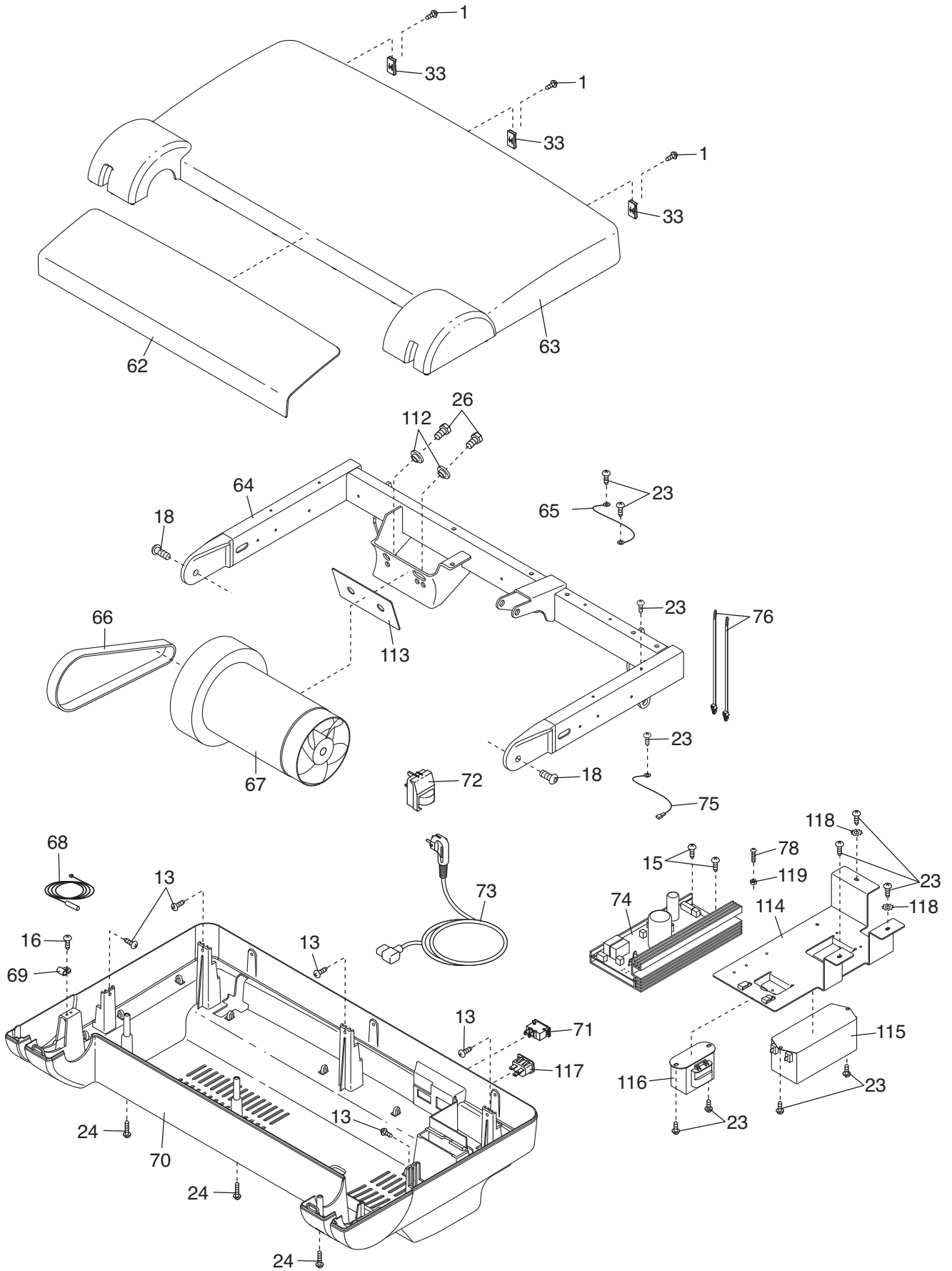



# EXPLODED DRAWING D—Model No. PETL91709.0

R0809A

