

EXPLODED DRAWING A

Model No. PETL99711.0 R0611A

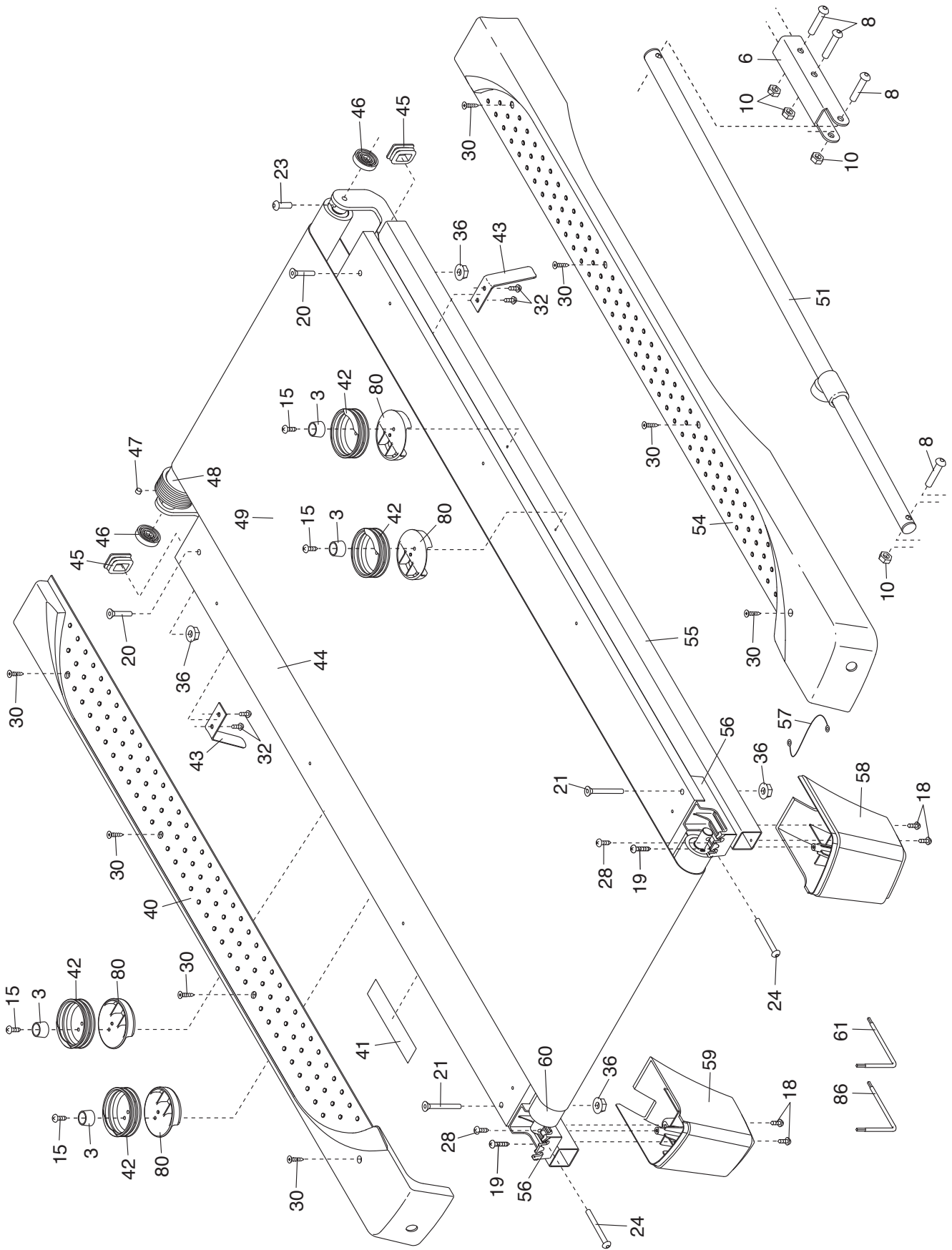

EXPLODED DRAWING B

Model No. PETL99711.0 R0611A

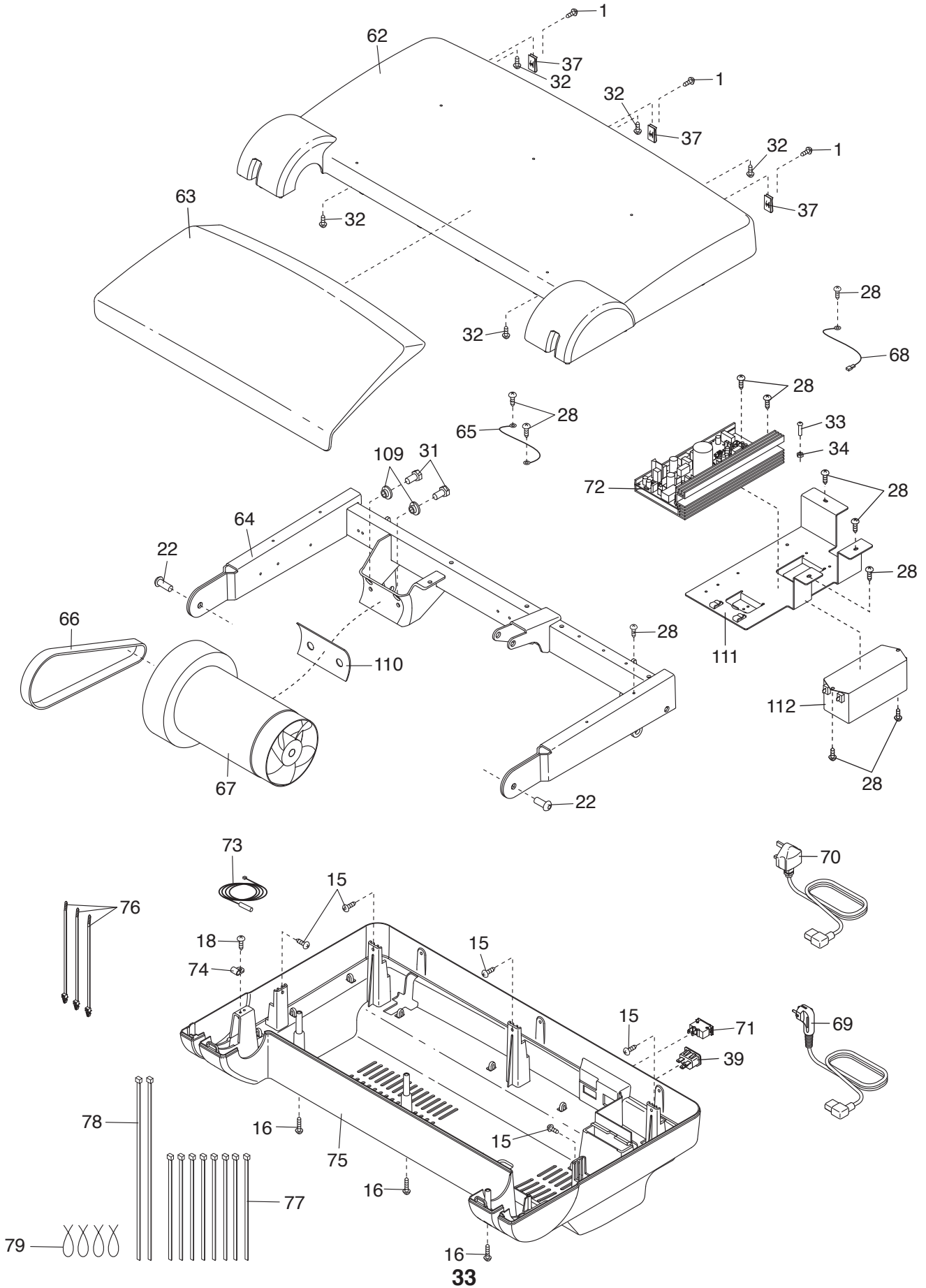

EXPLODED DRAWING C

Model No. PETL99711.0 R0611A

