

EXPLODED DRAWING A

Model No. PETL99713.1 R0614A

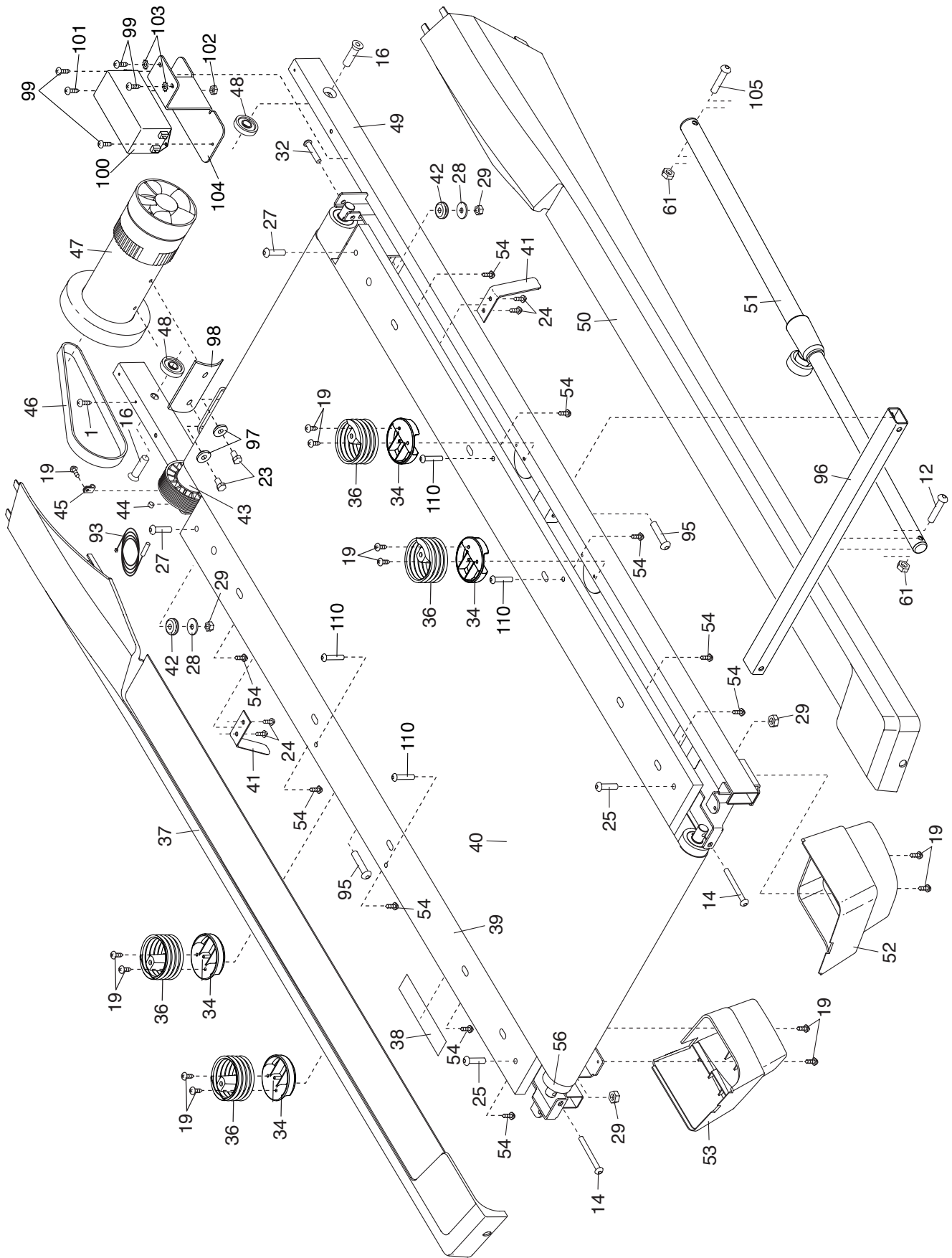

EXPLODED DRAWING B

Model No. PETL99713.1 R0614A

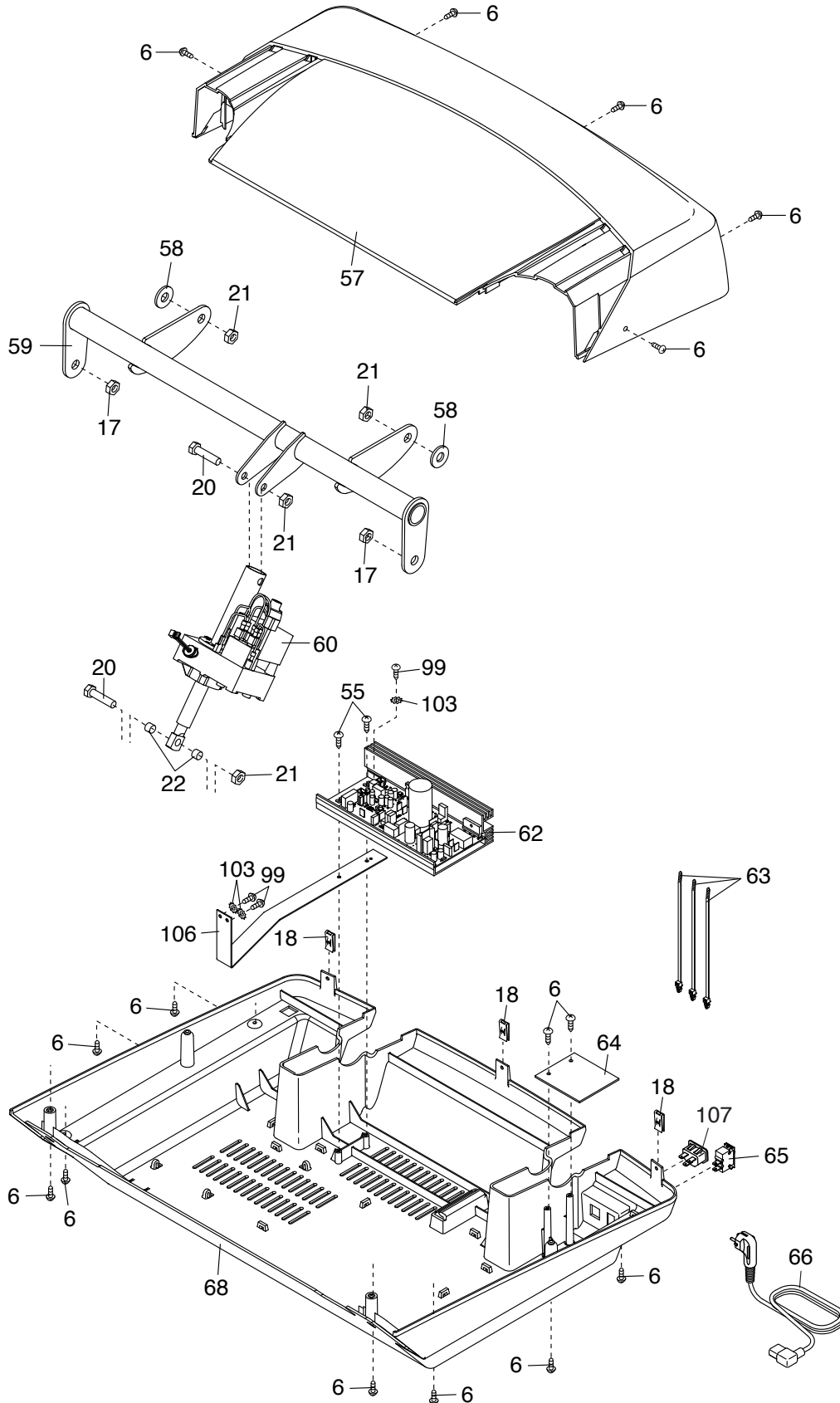

EXPLODED DRAWING C

Model No. PETL99713.1 R0614A

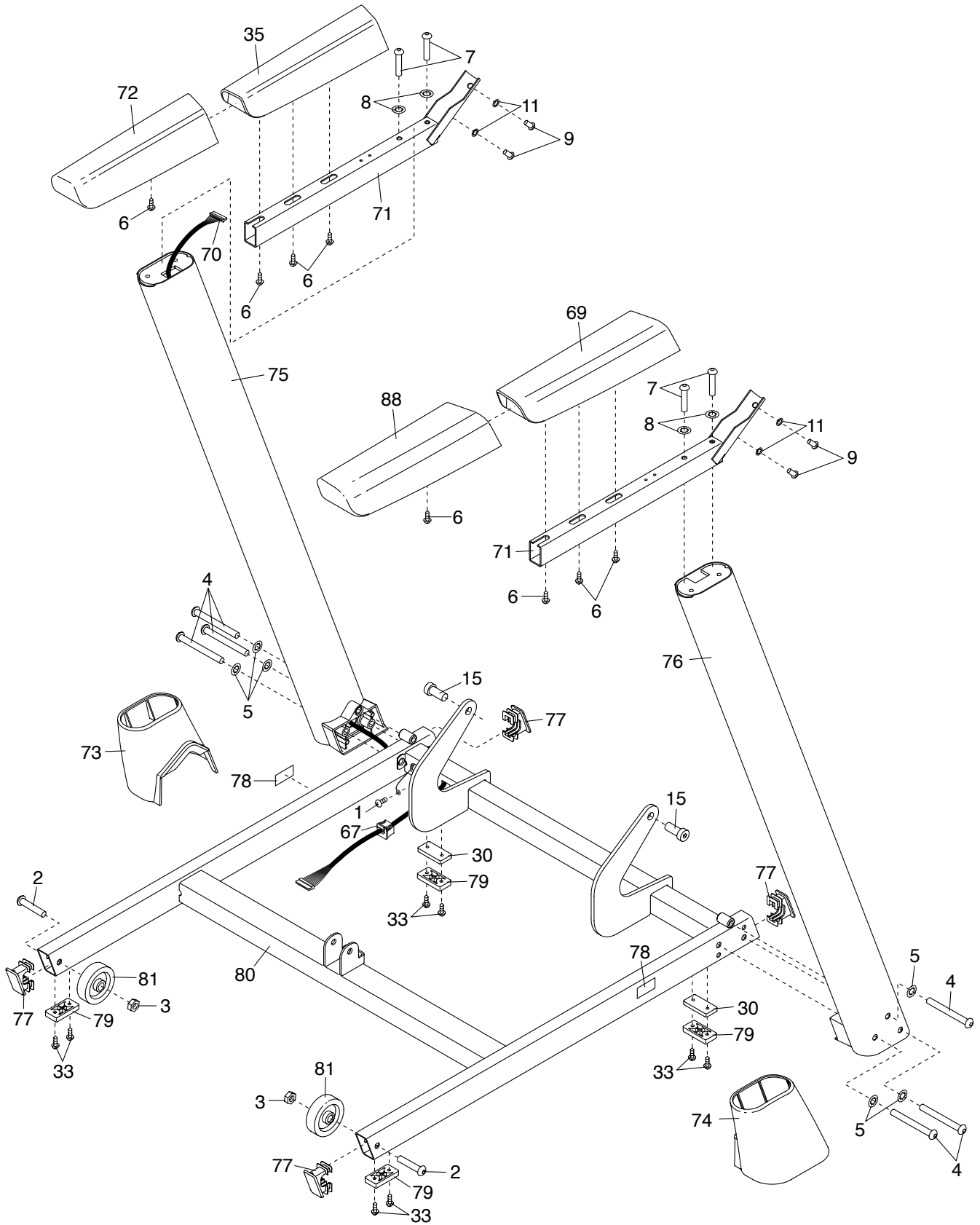

EXPLODED DRAWING D

Model No. PETL99713.1 R0614A

