

# EXPLODED DRAWING A

Model No. PETL99714.0 R1213A

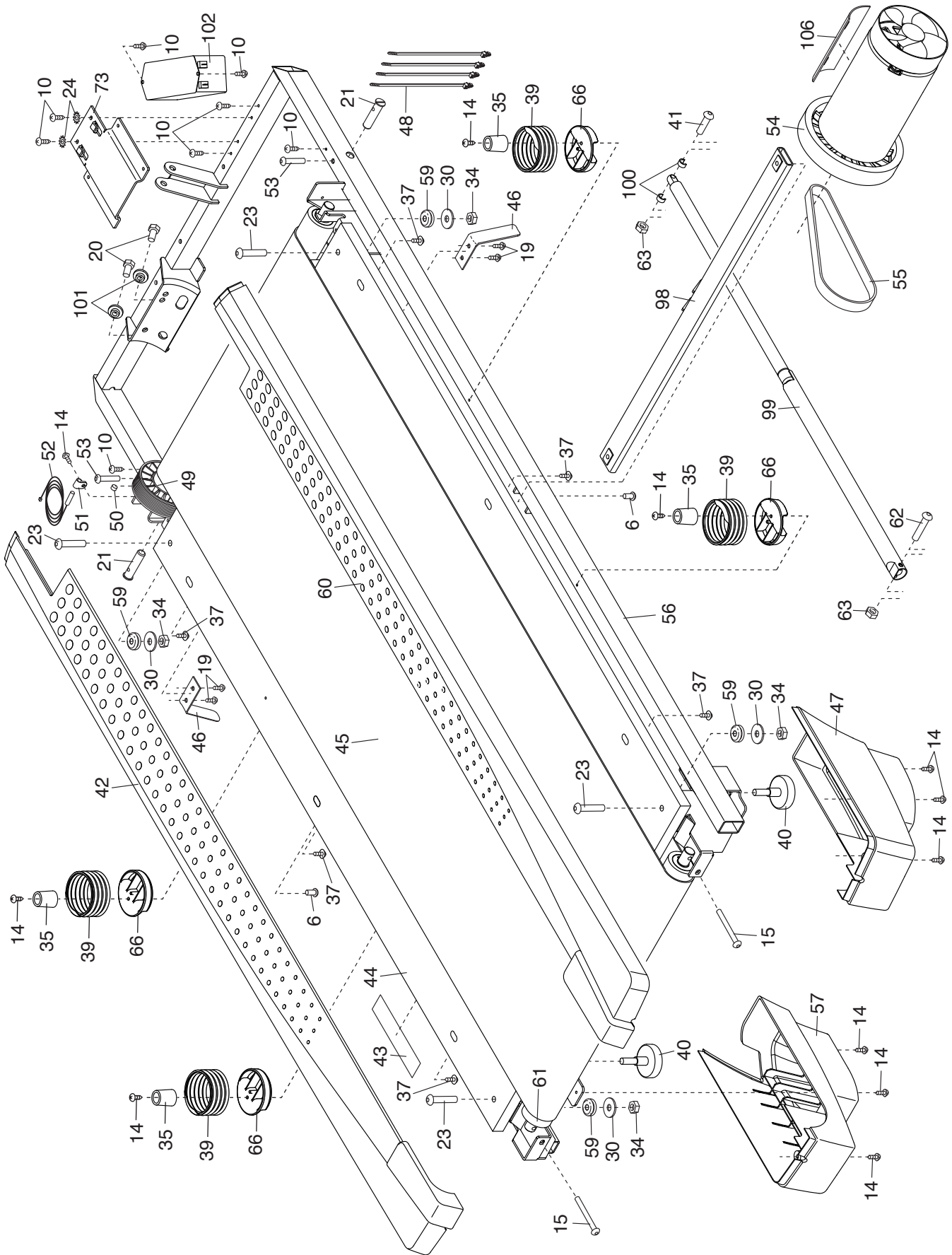

# EXPLODED DRAWING B

Model No. PETL99714.0 R1213A

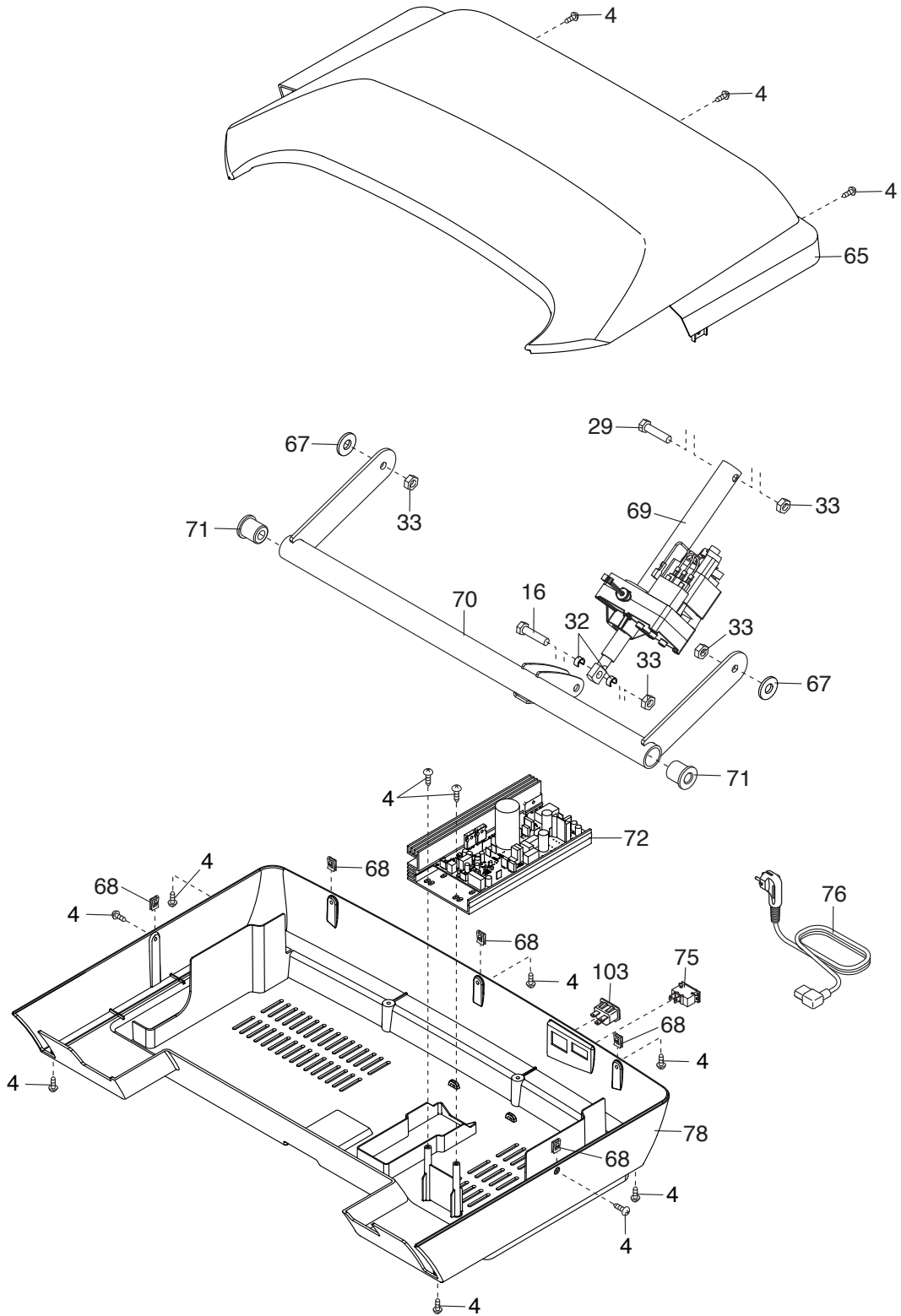

# EXPLODED DRAWING C

Model No. PETL99714.0 R1213A

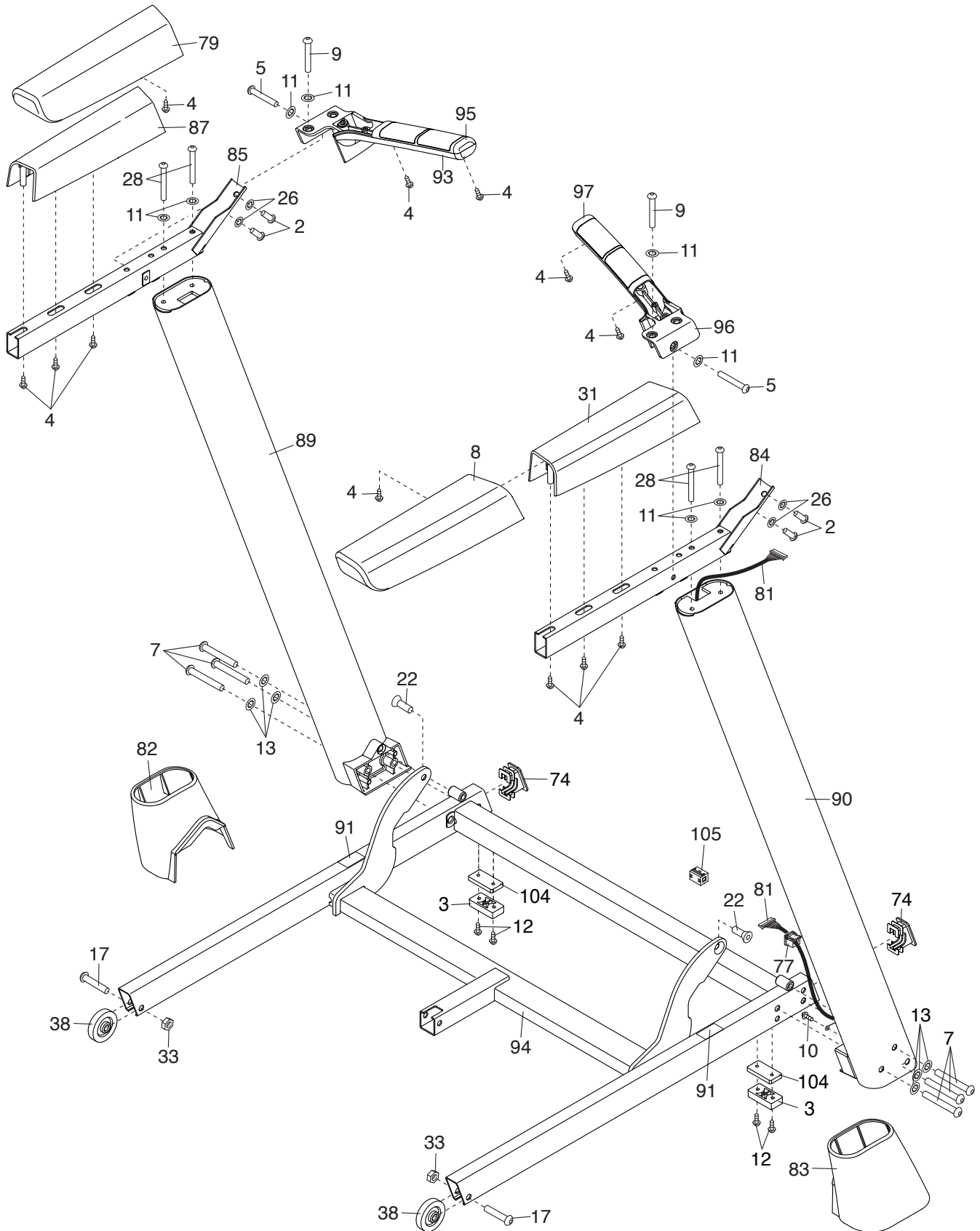

# EXPLODED DRAWING D

Model No. PETL99714.0 R1213A

