

EXPLODED DRAWING A

Model No. PETL99717.1 R0318A

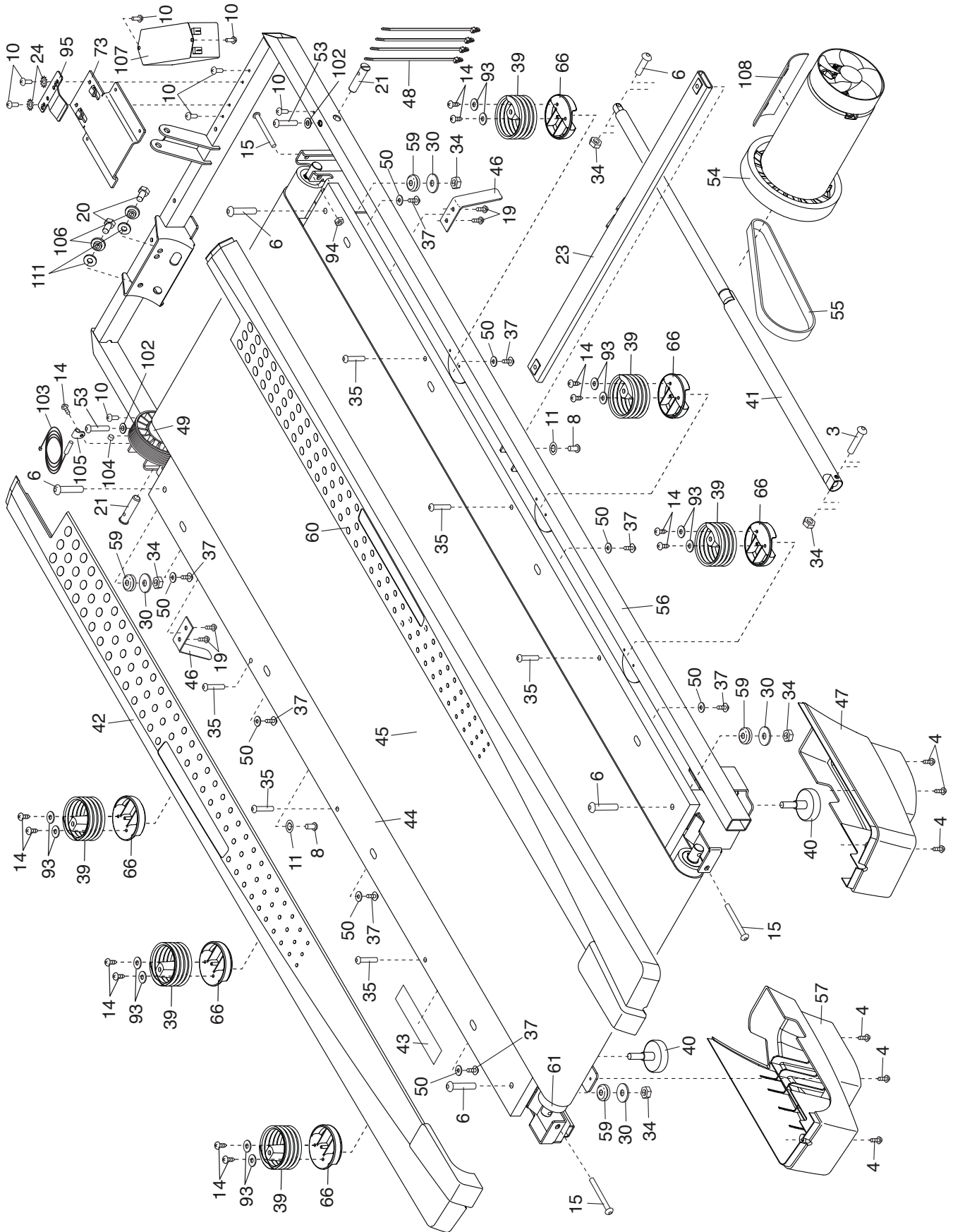

EXPLODED DRAWING B

Model No. PETL99717.1 R0318A

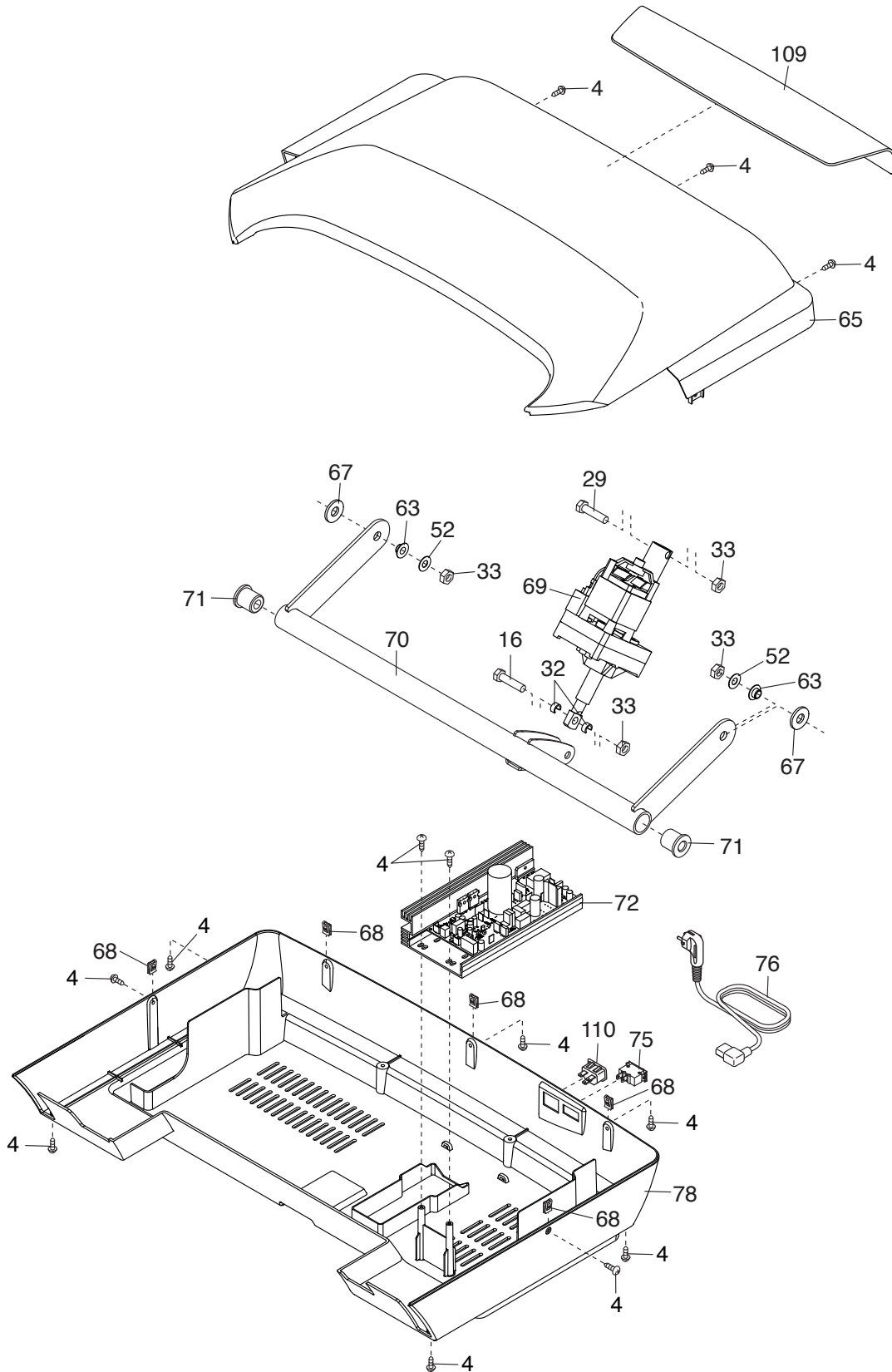

EXPLODED DRAWING C

Model No. PETL99717.1 R0318A

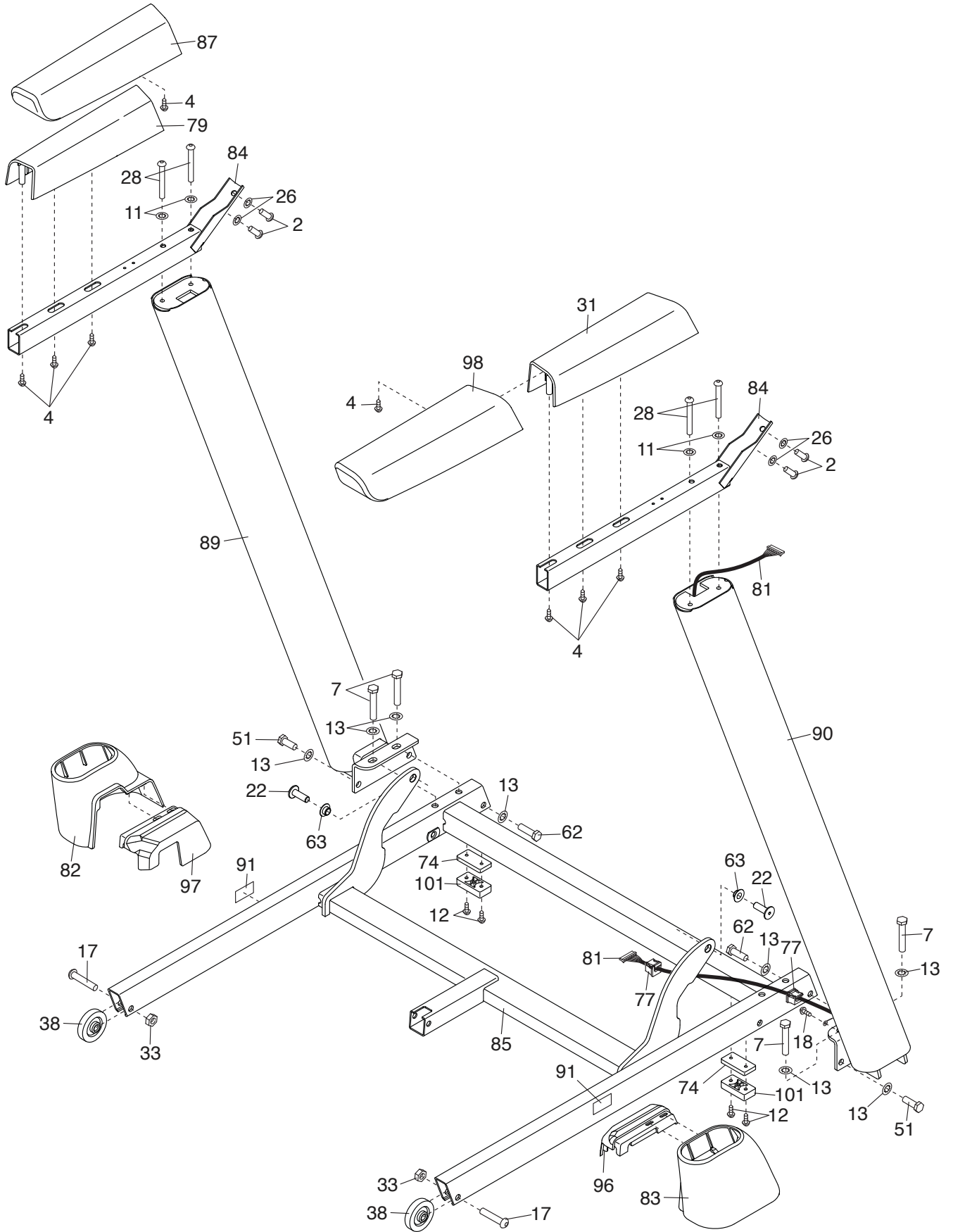

EXPLODED DRAWING D

Model No. PETL99717.1 R0318A

