

EXPLODED DRAWING A

Model No. PETL99816.0 R0316B

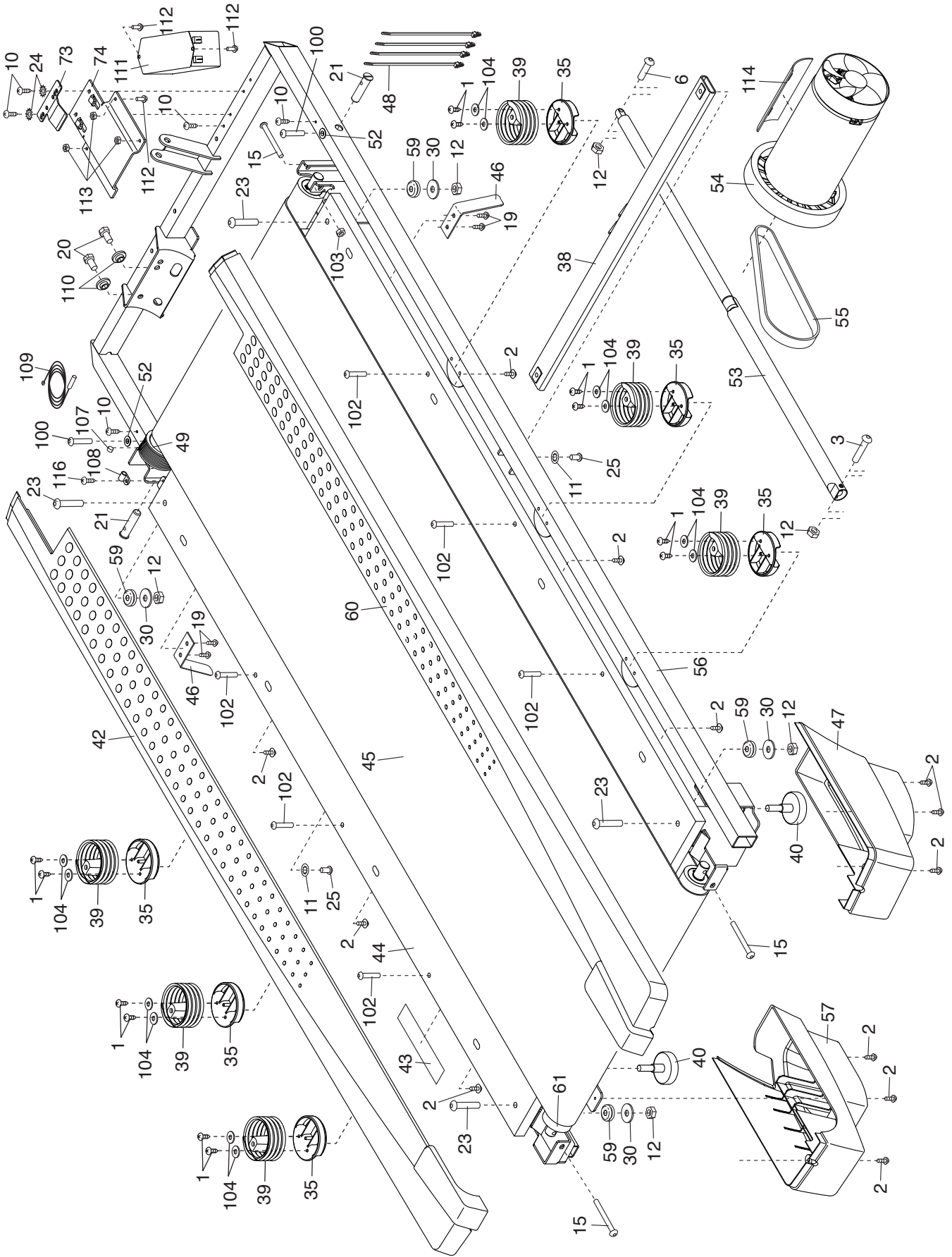

EXPLODED DRAWING B

Model No. PETL99816.0 R0316B

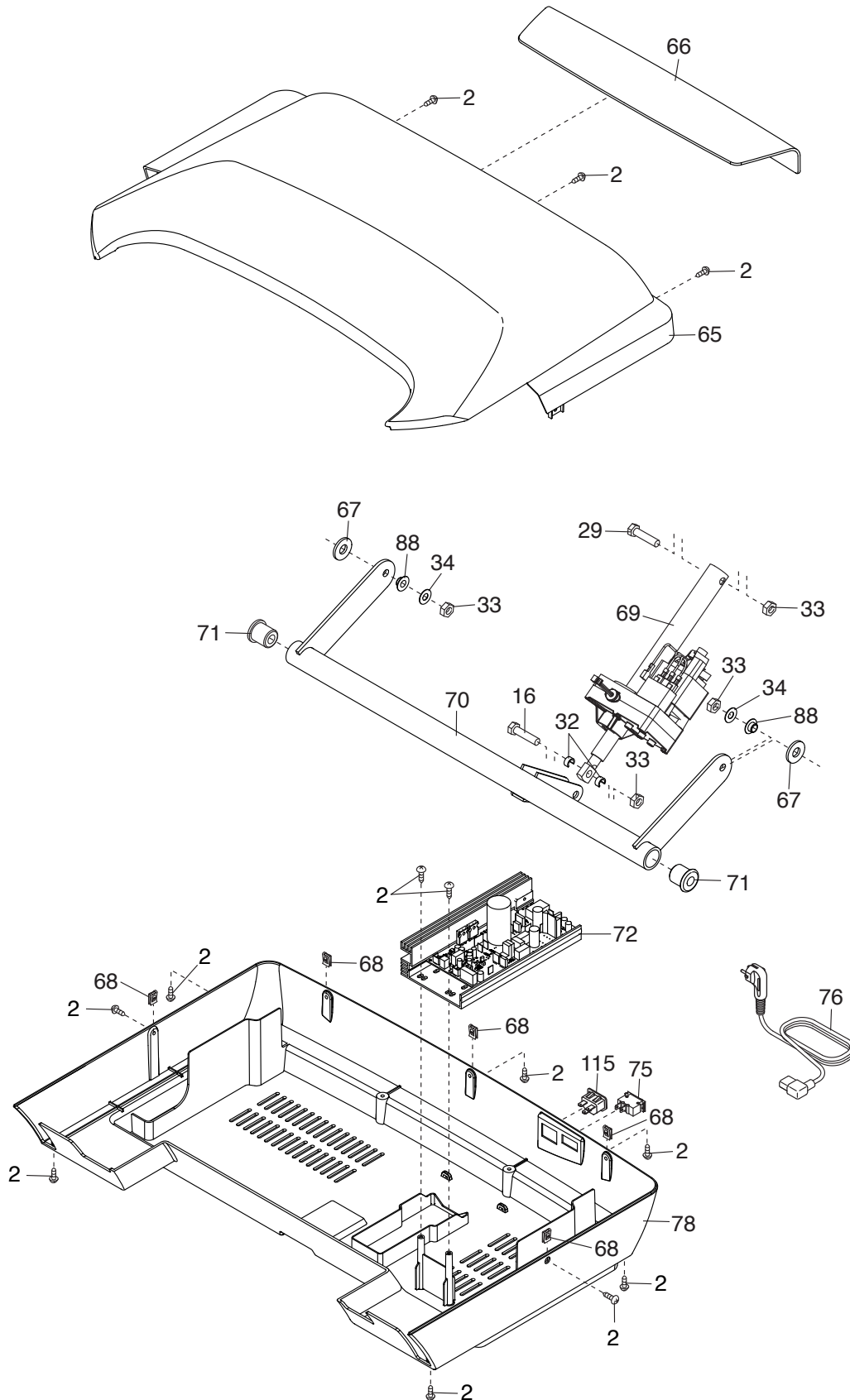

EXPLODED DRAWING C

Model No. PETL99816.0 R0316B

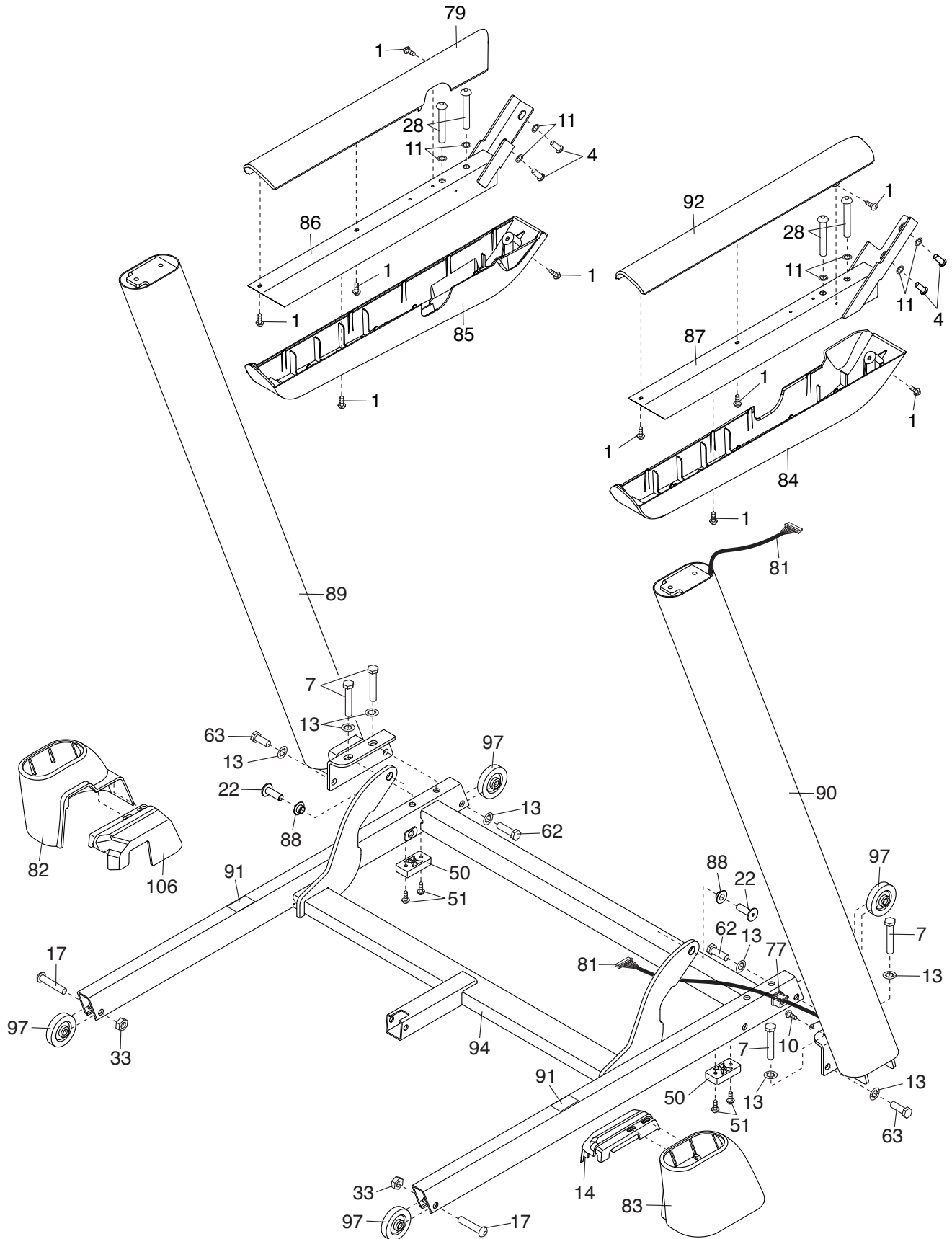

EXPLODED DRAWING D

Model No. PETL99816.0 R0316B

