

EXPLODED DRAWING A

Model No. PFEL01717.1 R1117A

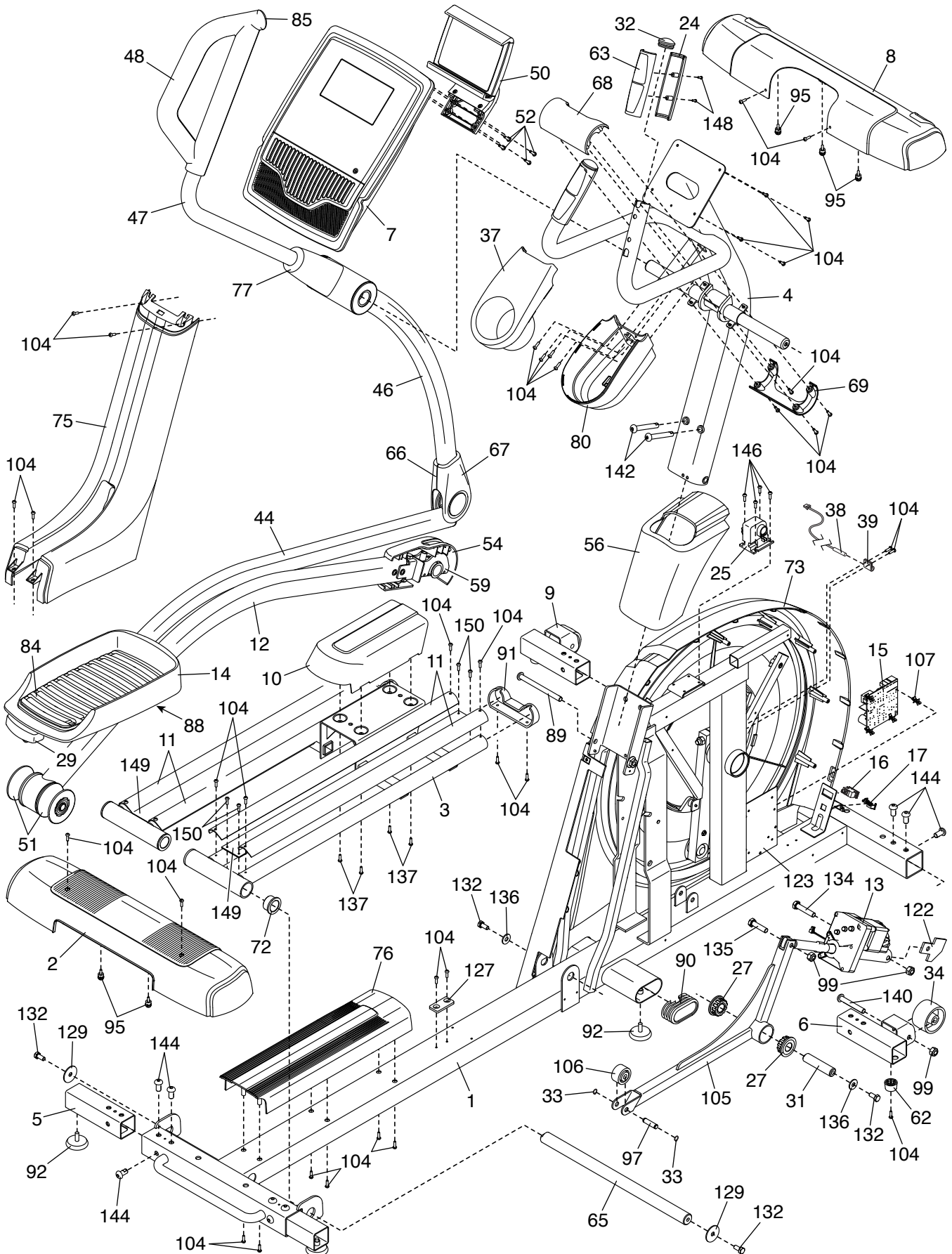

EXPLODED DRAWING B

Model No. PFEL01717.1 R1117A

