

EXPLODED DRAWING A

Model No. PFEL02915.0 R0517A

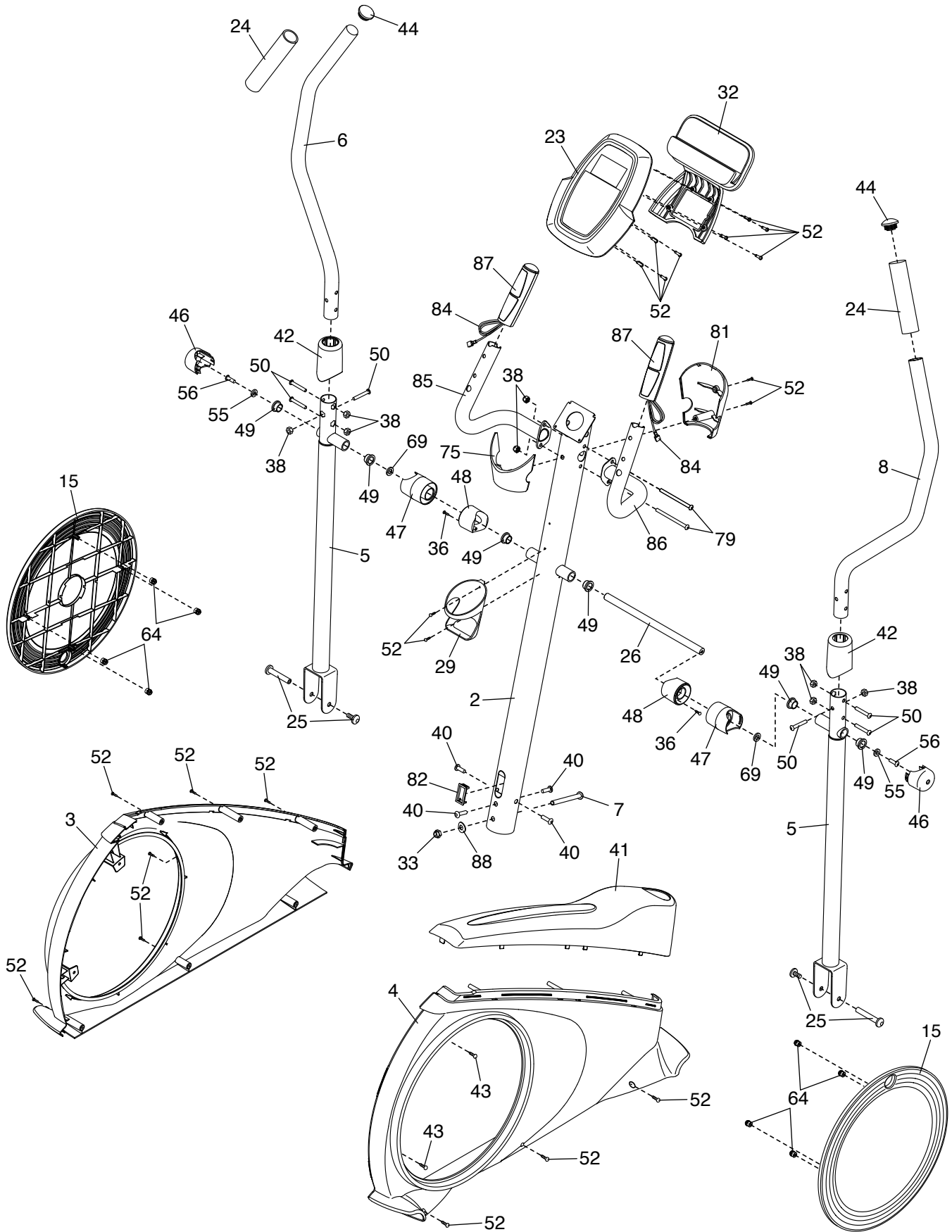

EXPLODED DRAWING B

Model No. PFEL02915.0 R0517A

