

# EXPLODED DRAWING A

Model No. PFEL02917.0 R0119A

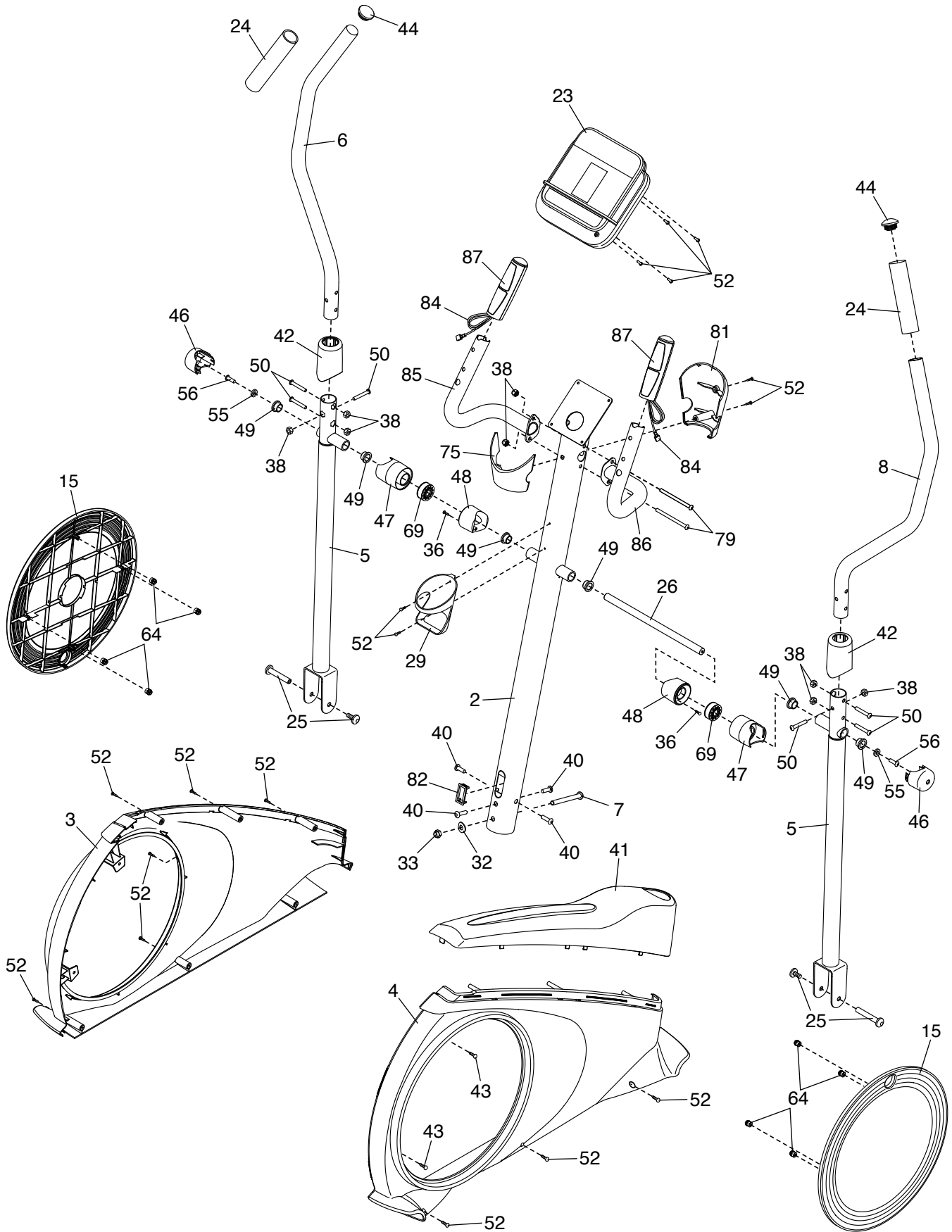

# EXPLODED DRAWING B

Model No. PFEL02917.0 R0119A

