

# EXPLODED DRAWING A

Model No. PFEL02917.1 R0617A

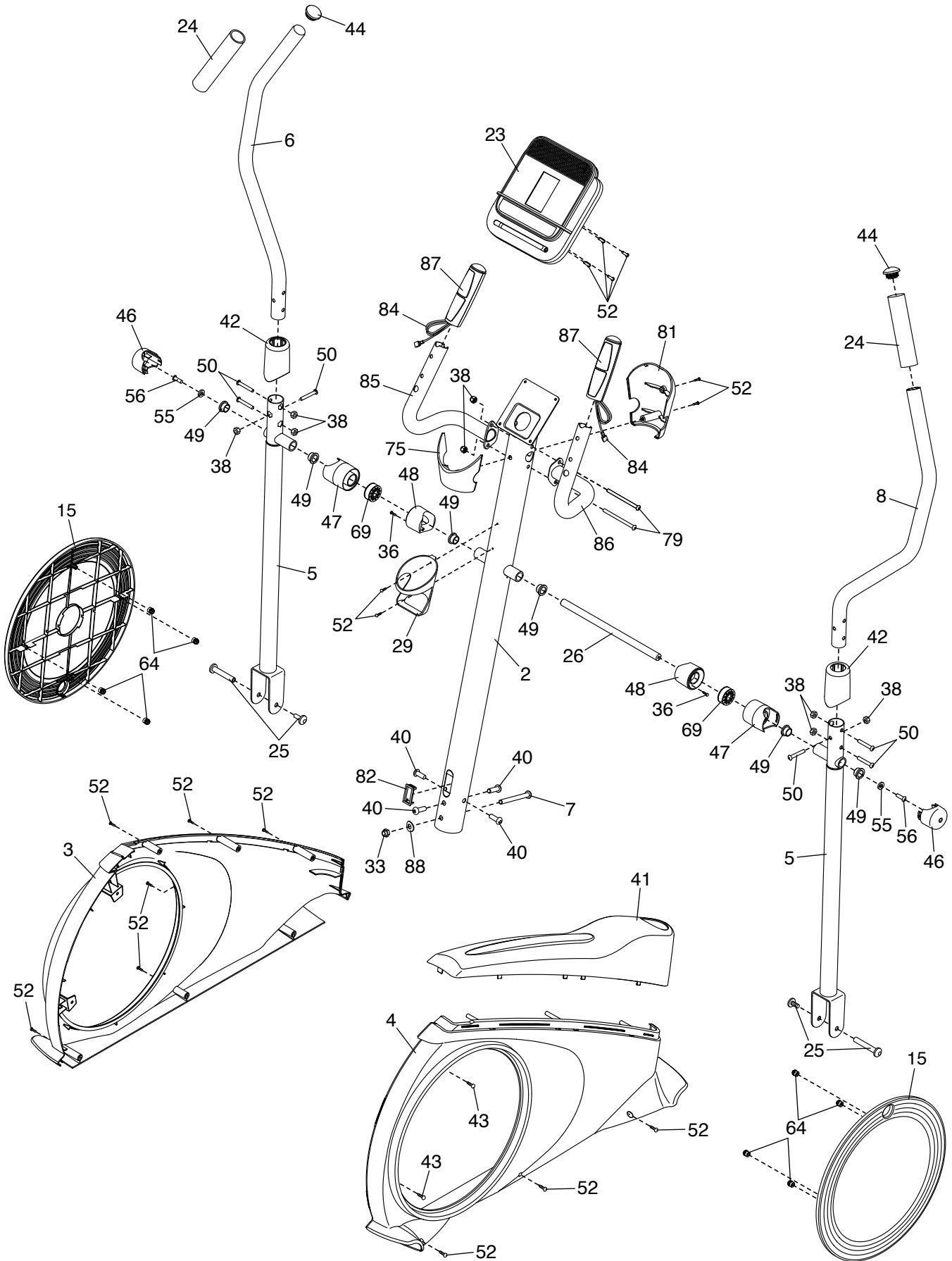

# EXPLODED DRAWING B

Model No. PFEL02917.1 R0617A

