

EXPLODED DRAWING A

Model No. PFEL02917.3 R0418A

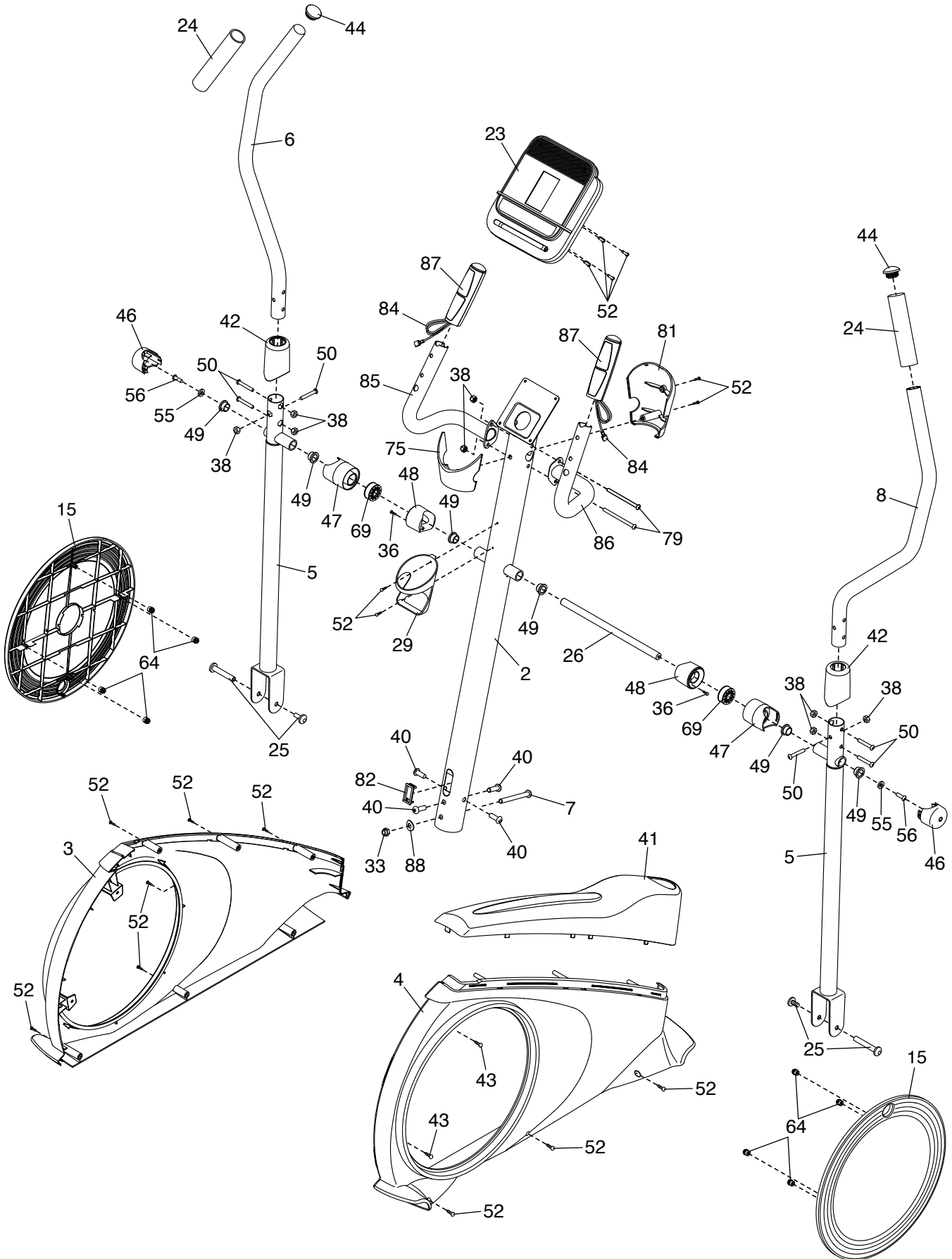

EXPLODED DRAWING B

Model No. PFEL02917.3 R0418A

