

EXPLODED DRAWING A

Model No. PFEL03009.1 R1110A

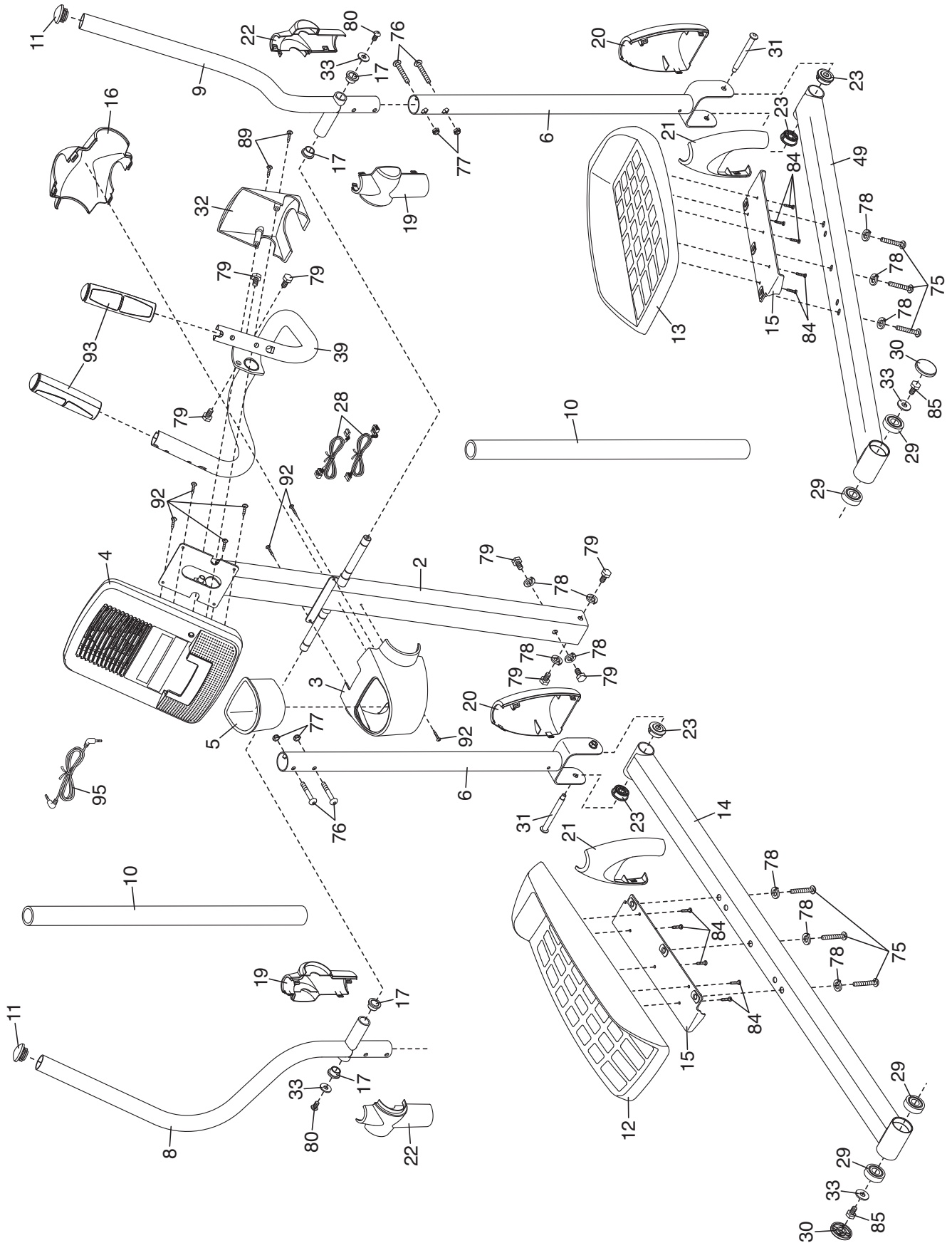

EXPLODED DRAWING B

Model No. PFEL03009.1 R1110A

