

# EXPLODED DRAWING A

Model No. PFEL03712.2 R0913A

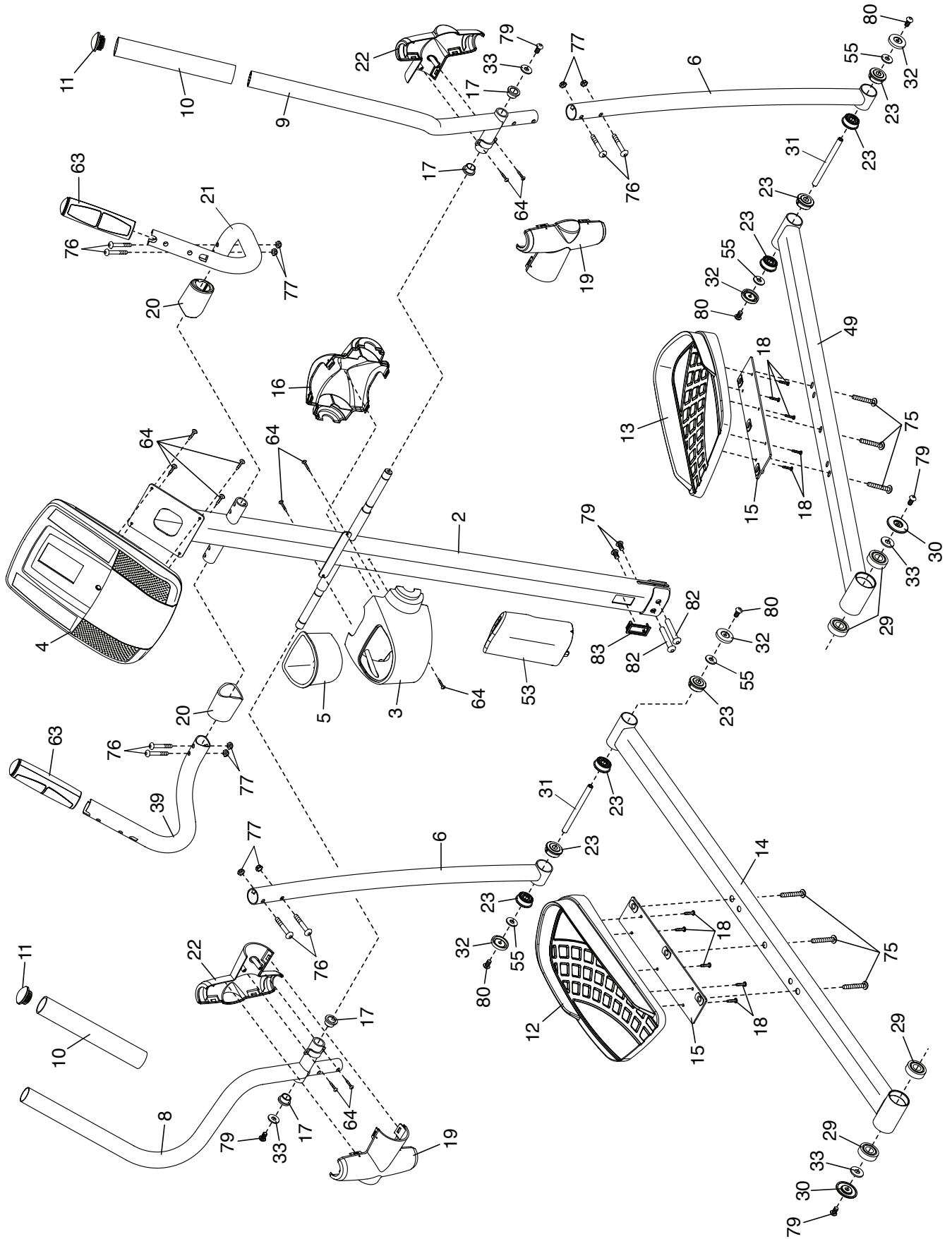

# EXPLODED DRAWING B

Model No. PFEL03712.2 R0913A

