

# EXPLODED DRAWING A

Model No. PFEL03916.1 R0817A

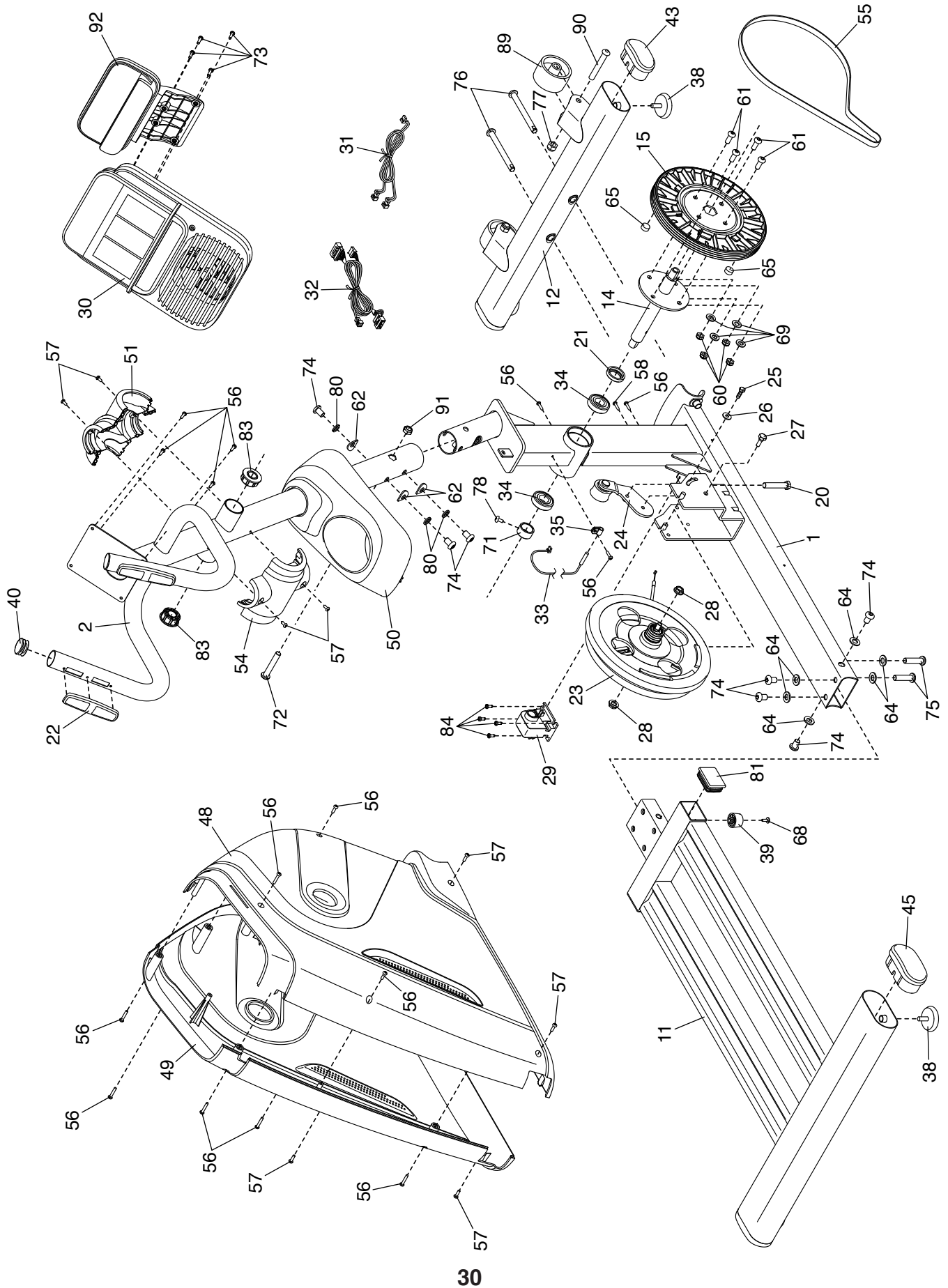

# EXPLODED DRAWING B

Model No. PFEL03916.1 R0817A

