

# EXPLODED DRAWING A

Model No. PFEL04817.1 R0319A

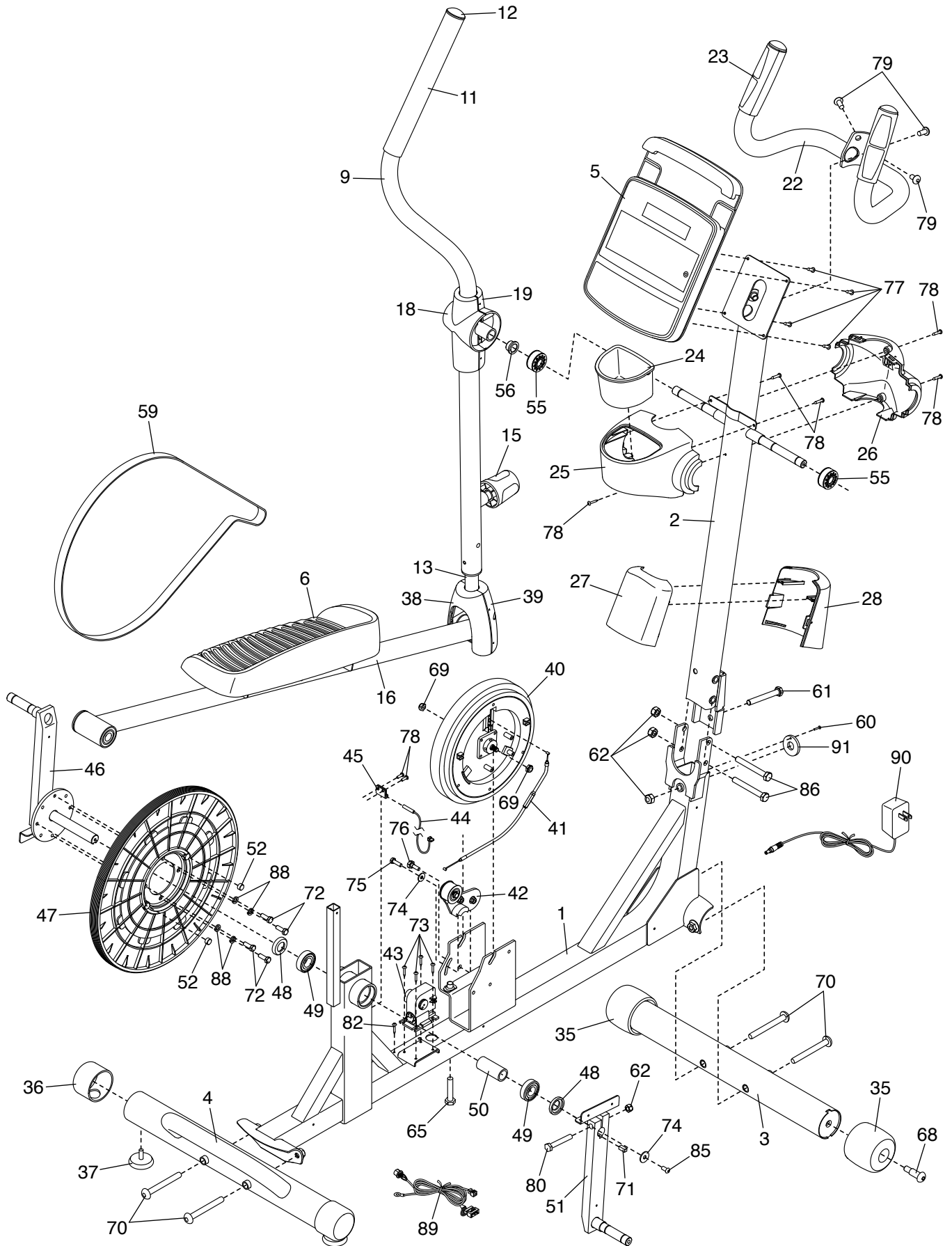

# EXPLODED DRAWING B

Model No. PFEL04817.1 R0319A

