

EXPLODED DRAWING A

Model No. PFEL04916.0 R1016A

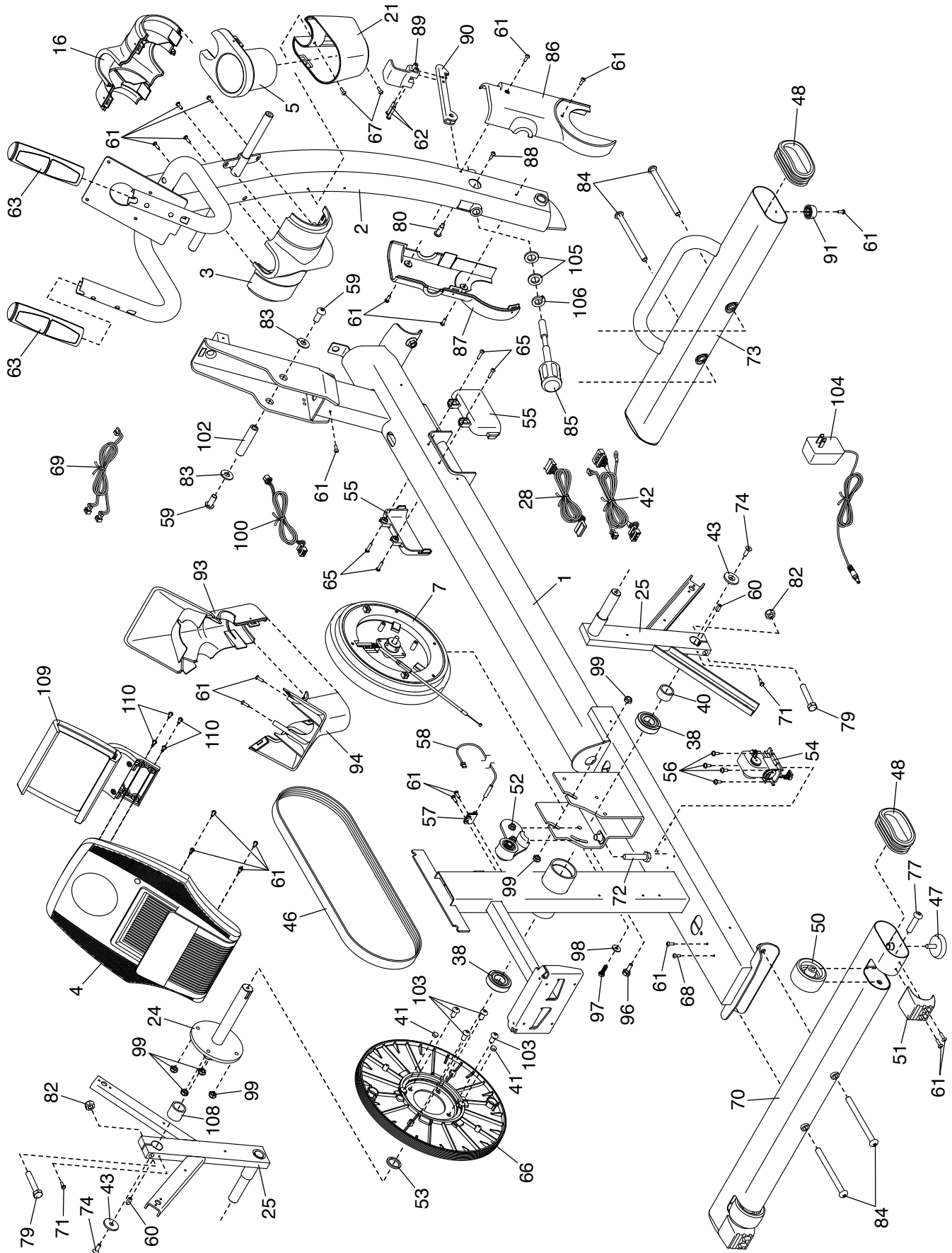

EXPLODED DRAWING B

Model No. PFEL04916.0 R1016A

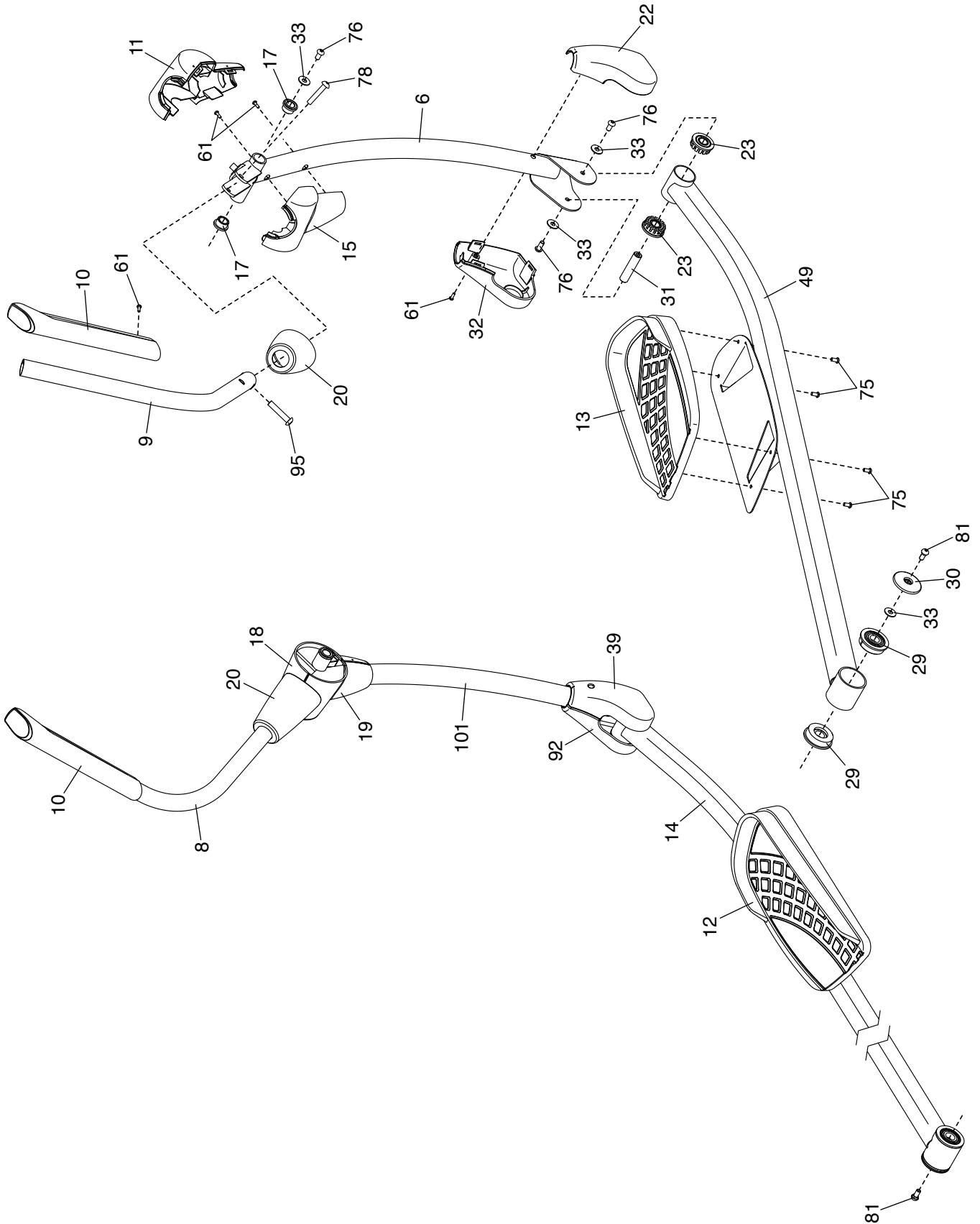

EXPLODED DRAWING C

Model No. PFEL04916.0 R1016A

